



Smart Implant Solutions



FULL DIGITAL WORKFLOW

THINK DIGITAL 2026

GUÍA DE PRODUCTOS



Smart Implant Solutions

ESPECIALIZADOS EN LA FABRICACIÓN Y DISTRIBUCIÓN DE ADITAMENTOS DENTALES.

Smart Implant Solutions nace fruto del amor a nuestra profesión. Ofrecemos soluciones innovadoras, preparadas para el futuro digital, que cubren las necesidades del mercado en materia de aditamentos para implantes.

Un gran equipo de profesionales trabaja a diario para encontrar soluciones a sus necesidades. Colaboramos con profesionales del sector dental (odontólogos, protésicos,...) que nos ayudan a diseñar los mejores aditamentos y estar a la última en las tendencias del mercado.

Nos dedicamos a innovar con seriedad, pero también con pasión.

Smart Implant Solutions recientemente ha ampliado sus instalaciones, reubicando la planta de fabricación en Etxebarria, Bizkaia y manteniendo sus oficinas centrales en el Parke Tecnológico de Gipuzkoa, la red de parques tecnológicos del País Vasco en los que únicamente están ubicadas empresas, centros tecnológicos, unidades de investigación de las universidades y centros de investigación de alto componente tecnológico.



V23/02



VIDEO

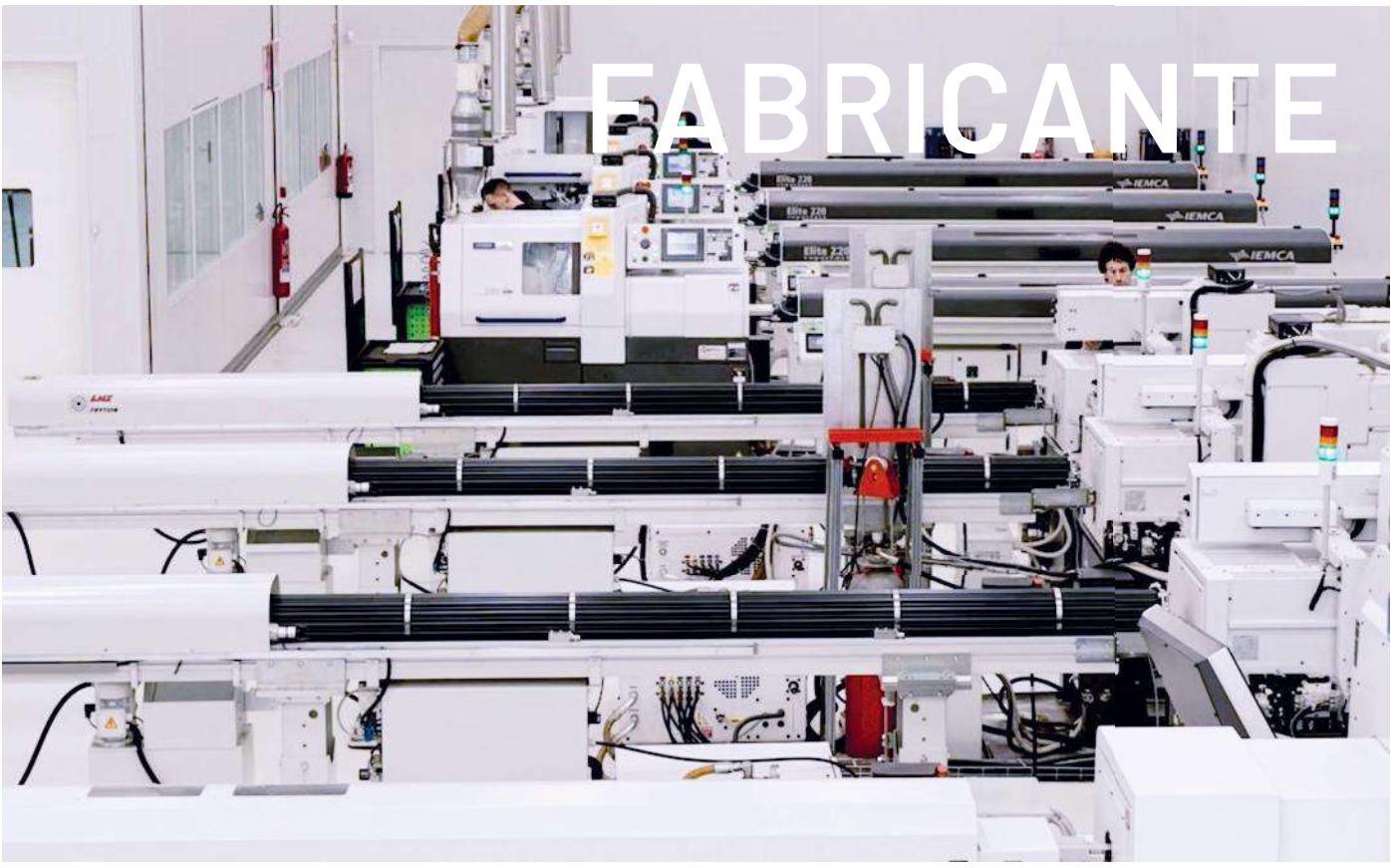
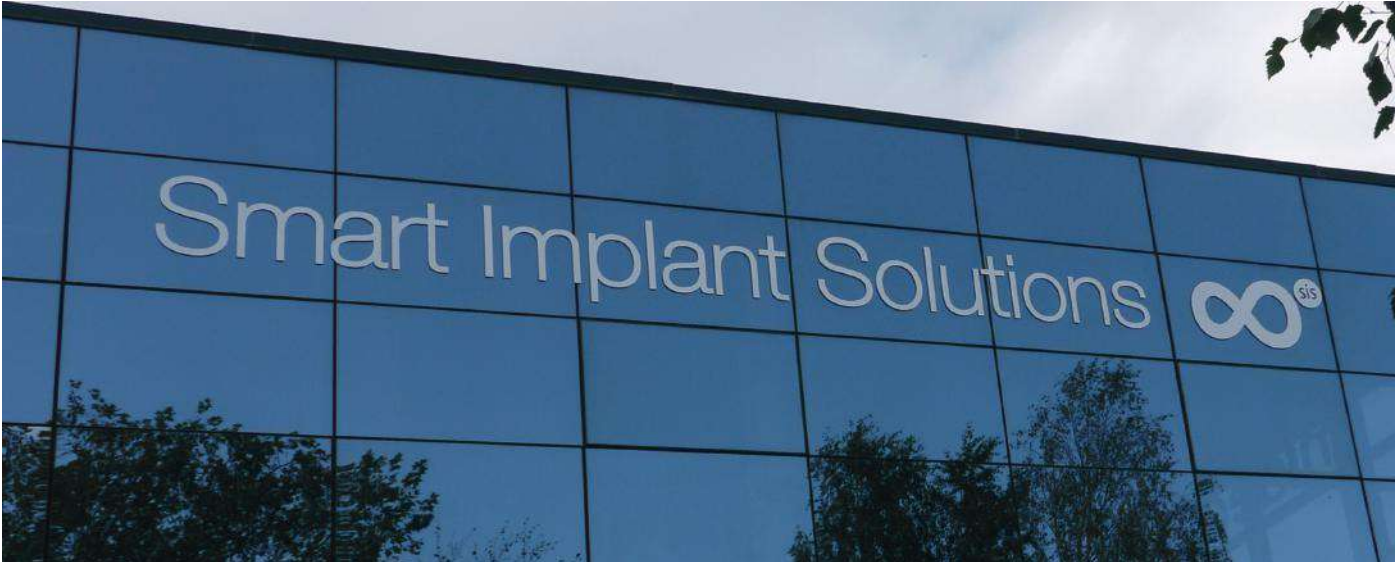



SMART IMPLANT SOLUTIONS [∞]

Calidad	5
Ensayos / Etiquetado	6

PRODUCTOS SMART

Librerías Smart	8
Scanbody intra/extra-oral	11
Análogo tradicional y digital	12
Smart Ti-Bases	13
Smart Angle	15
Ti-Bases Cerec®	16
Multi-Unit SIS	17
Multi-Unit angulado	18
Multi-Unit mini	20
Locator®/SIScator y angulado 15°	27
BIOCARB	29
BIOGOLD	30
Tapones de cicatrización	31

GENERAL

Instrumentos para implantología	90
Especificaciones técnicas de tornillos	95

Las marcas mencionadas son propiedad de de sus respectivos propietarios.

CATÁLOGO GENERAL DE CONEXIONES

[LIBRERÍA DIGITAL]

CEREC® Ti-Base	16	N/A
MULTI-UNIT Aditamentos	19	1300
MULTI-UNIT mini Aditamentos	21	N/A
SiScator/Locator® Housing/Gomas	28	N/A
NOBEL BIOCARE® BRANEMARK® Hexágono Externo	33	0100
BIOMET 3I® OSSEOTITE® Hexágono Externo	35	0200
MIS® SEVEN® Hexágono Interno	37	0160
ZIMMER® SCREW-VENT® Hexágono Interno	39	0300
BIOMET 3i® CERTAIN® Hexágono Interno "Click"	41	0400
ASTRA® TECH OSSEOSPEED® Cónica Interna	43	0500
STRAUMANN® TISSUE LEVEL® Octógono	45	0600
BTI® INTERNA Tetralobular Interno	47	0700
BTI® CORE® Tetralobular Interno	49	0700
NOBEL BIOCARE® REPLACE SELECT® Trilobular	51	0800
NOBEL BIOCARE® NOBELACTIVE® Interna Activa	53	0900
STRAUMANN® BONE LEVEL® Interna	55	1100
BTI® Hexágono Externo	57	0120/0100
SWEDEN & MARTINA® PREMIUM KOHNO® Interna	59	1400
PHIBO® TSH® Hexágono Externo	61	1500/0100
BIOHORIZONS® TAPERED® Hexágono Interno	63	1600
MIS® C1/V3 Hexágono Cónico Interno	65	1800
NEOBIOTECH® IS SYSTEM Cónica Interna	67	2200
ASTRA® TECH SYSTEMTM EVOLUTION Cónica Interna	69	2300
NEODENT GM® (Helix GM®, Drive GM®, Titamax GM®) Cónica Interna	71	2400
MEGAGEN ANYRIDGE® Cónica Interna	73	2500
DENTSPLY® XIVE® Cónica Interna	75	2600
DENTSPLY® ANKYLOS® Interna Ankylos	77	2700
OSSTEM® TS/ HIOSSEN® ET Cónica Interna	79	2800
DIO® UFII® Cónica Interna	81	2900
DENTIUM SUPERLINETM & IMPLANTIUM® Cónica Interna	83	3000
KLOCKNER® VEGA® Hexágono Interno	85	3200
ANTHOGYR® AXIOM® BL	87	3300
BIOTECH DENTAL® KONTACT®	88	3400
MEGAGEN ANYONE® Cónica Interna	89	3600
KLOCKNER® SK2® Hexágono Externo Alto	91	1000

CALIDAD

Para Smart Implant Solutions la calidad es lo primero.
Contamos con todos los certificados que garantizan la calidad de nuestros productos.



CERTIFICATO CE
Dichiarazione di approvazione del sistema qualità
SMART IMPLANT SOLUTIONS, S.L.



CERTIFICATE N. 8124 SMA4
SMART IMPLANT SOLUTIONS, S.L.
ISO 13485:2016

- **LICENCIA DE FABRICANTE DE PRODUCTOS SANITARIOS**
Agencia Española del Medicamento y Productos Sanitarios.
- **ISO 13485**
Garantía de Gestión de la Calidad en la Fabricación de Productos Sanitarios.
- **MARCADO CE**
En los productos.



CSQ MED
ISO 13485

ASOCIADOS A LA FEDERACIÓN ESPAÑOLA DE EMPRESAS DE TECNOLOGÍA SANITARIA.



federación española de empresas de **TECNOLOGÍA SANITARIA**



“Tenemos tanta confianza en nuestros productos, que nuestro logotipo es el símbolo de infinito, el período de garantía que ofrecemos”.

GARANTÍA DE CALIDAD

Smart Implant Solutions únicamente emplea titanio de la más alta calidad (grado médico) para la fabricación de todos sus componentes.
Ti6AlV4 GRADO 5 ELI SEGÚN NORMA: ASTM F136 ISO 5832/3

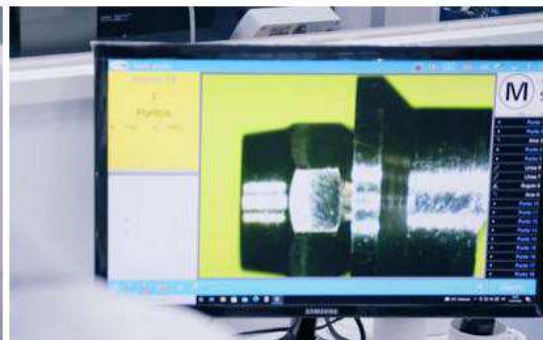

ENSAYOS

MECÁNICOS SEGÚN LA NORMA UNE-EN ISO 14801



Los productos de Smart Implant Solutions pasan por nuestro banco de pruebas donde les realizamos **ensayos mecánicos** según la norma **UNE-EN ISO 14801**.

En estos ensayos comprobamos:

- **TORSIÓN**
Para determinar el par torsor máximo que soporta el tornillo interno.
- **COMPRESIÓN**
Para determinar la fuerza máxima soportada por el conjunto.
- **FATIGA**
Para determinar la fuerza máxima a la que el conjunto tiene vida infinita (5 millones de ciclos).

ETIQUETADO

DE PRODUCTOS NORMATIVA MDR 2017/745

1. Descripción de la conexión.
2. Descripción del producto.
3. Código.
4. Referencia de producto.
5. Número de lote.
6. Fecha de fabricación.
7. Código UDI de identificación de producto sanitario.
(01) O + GTIN
(11) Fecha de Fabricación.
(10) N^o de lote.
8. Símbolo de "producto de un solo uso".
9. Símbolo MD de indicación de producto sanitario.
10. Marcado CE con número de Organismo Notificado (en el caso de productos de Clase II).
11. Símbolo de "consultar instrucciones de uso".
12. Símbolo de "Sólo para uso profesional".
13. Datos completos del fabricante.
14. Símbolo de "Producto no estéril".

1 Conexión
Producto
Connection
Product
2 Product
3 SIS-XXXX
4 REF SIS-[AA][BB].[C][D].[EE][FFF][GGG].[H]
5 LOT XXXXXXXX
6 YYY-YY-MM-DD
7 (01) XXXXXXXXXXXXXXXX
(11) XXXXXX
(10) XXXXXX
8 **9** **10** **11** **12**
13 Smart Implant Solutions S.L.
Parque Científico y Tecnológico
P^o Mikeletegi 69 I 20009 San Sebastián (Spain)
T. (+34) 943 322 812
pedidos@smartimplantsolutions.com
14 Extrair producto del envase. Tratamiento en autoclave a 121°C (249°F) utilizando una bolsa aprobada por la FDA durante 30 min., secado 30min. Discard the package. Autoclaving the product using an FDA-cleared pouch at 121°C (249°F) for 30min. and a drying time for 30min.

1



SCAN

2



DESIGN

exocad

3shape



blenderfordental



dental wings

3

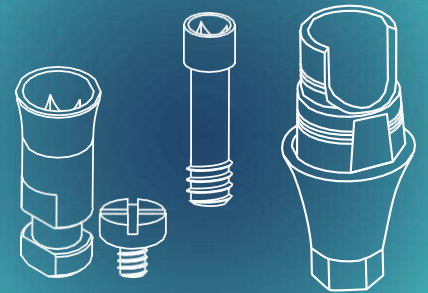

PRODUCE

FULL DIGITAL WORKFLOW

PRODUCTO SMART

THINK DIGITAL

LIBRERÍAS SMART

¿CÓMO DESCARGAR LIBRERÍAS DE IMPLANTES?



PASO 1

1. Desde un ordenador, conectarse a:
www.sisaditamentos.com.mx

2. En el menú principal, en el botón **LIBRERÍAS**, seleccione **Exocad**.

Área privada Exocad librerías Smart Ti-Bases
Para acceder al área de Exocad Librerías para Smart Ti-Bases, debes introducir los siguientes datos.

Nombre*

Empresa*

País*

Correo electrónico*

Acepto la política de privacidad

Send

PASO 2

Para acceder al área de las Librerías Exocad, debe rellenar y enviar el formulario. Una vez rellenado y enviado, espere unos segundos y será dirigido automáticamente al área de las librerías Exocad.

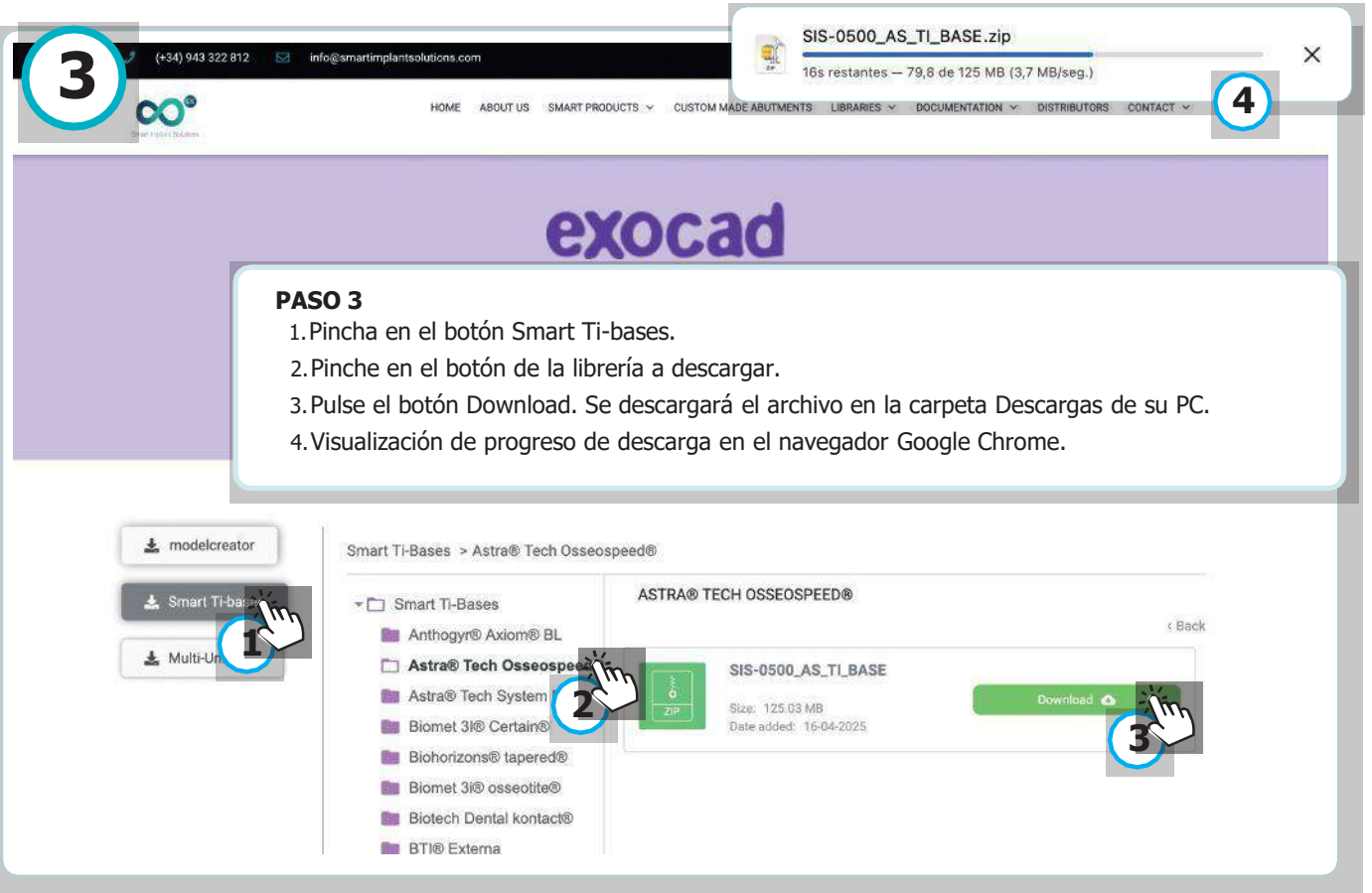

PASO 3

1. Pincha en el botón Smart Ti-bases.
2. Pinche en el botón de la librería a descargar.
3. Pulse el botón Download. Se descargará el archivo en la carpeta Descargas de su PC.
4. Visualización de progreso de descarga en el navegador Google Chrome.

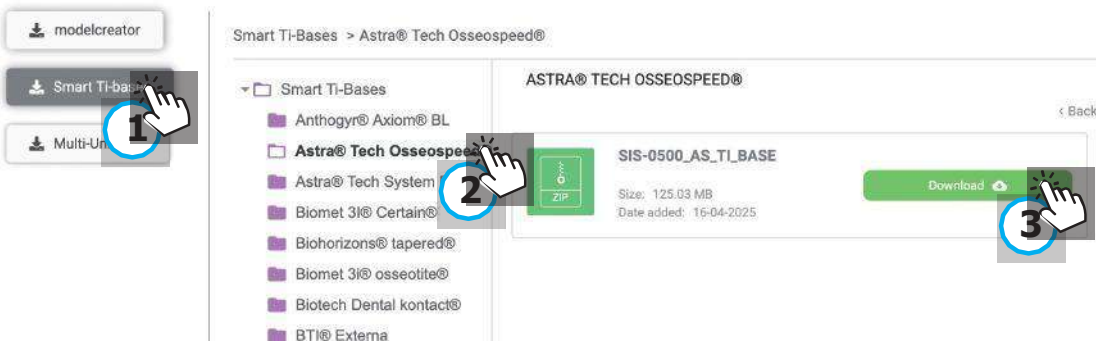

PASO 4

DESCOMPRESIR ARCHIVO.ZIP

1. Vaya a la carpeta Descargas de su PC.
2. Descomprima el archivo descargado.

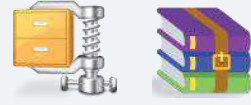

Para descomprimir el archivo puede utilizar un descompresor estándar descargado de internet como WinZip o WinRar.

LIBRERÍAS ASOCIADAS AL SCANBODY Ti



SCANBODY Ti

Librerías para trabajar con Ti-Bases, bases de CrCo (sobrecolable) y con análogos digitales, desde escaneado intraoral o de sobremesa.

SCANBODY D (Implant Level)

Librerías para los scanbodies de titanio. Son para trabajar directo a implante sobre análogo digital, desde escaneado intraoral o de sobremesa.



Gratis para:

- Ti-Bases.
- Bases de Cr-Co (sobrecolable).
- Análogos digitales.
- Directo a implante.

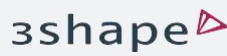

Gratis para:

- Ti-Bases.
- Bases de Cr-Co (sobrecolable).
- Análogos digitales.



Gratis para:

- Ti-Bases.
- Bases de Cr-Co (sobrecolable).
- Análogos digitales.



Gratis para:

- Ti-Bases.
- Bases de Cr-Co (sobrecolable).
- Análogos digitales.

Si desea consultar otras opciones para 3shape y dentalwings, envíe un e-mail a la dirección de correo:

info@sisaditamentos.com.mx

GUIAS DE INSTALACIÓN

Para más información sobre la instalación de librerías tiene disponible en el apartado web de "LIBRERÍAS" las guías de instalación en PDF.





• LIBRERÍAS ASOCIADAS AL SCANBODY TI

SCANBODY TI

Librerías para trabajar con Ti-Bases, bases de CrCo (sobrecolable) y con análogos digitales, desde escaneado intraoral o de sobremesa

SCANBODY D (Implant Level)

Librerías para los scanbodies de titanio. Son para trabajar directo a implante sobre análogo digital, desde escaneado intraoral o de sobremesa.



• **SCANBODY INY**

Librerías para trabajar con el scanbody que se entrega con cada Ti-base. Sirve para trabajar sobre Ti-base o sobre base de CrCo (sobrecolable).

Este escaneado siempre se hace con la Ti-base estándar (altura más baja).

La selección de altura gingival o cementable se hace en exocad.

<p>Gratis para:</p> <ul style="list-style-type: none"> • Ti-Bases. • Bases de Cr-Co (sobrecolable). • Análogos digitales. • Directo a implante. 	<p>Gratis para:</p> <ul style="list-style-type: none"> • Ti-Bases. • Bases de Cr-Co (sobrecolable). • Análogos digitales. 	<p>Gratis para:</p> <ul style="list-style-type: none"> • Ti-Bases. • Bases de Cr-Co (sobrecolable). • Análogos digitales.

Si desea consultar otras opciones para 3shape y dentalwings, envíe un e-mail a la dirección de correo:

info@smartimplantsolutions.com

GUIAS DE INSTALACIÓN

Para más información sobre la instalación de librerías tiene disponible en el apartado web de LIBRERÍAS las guías de instalación en PDF.

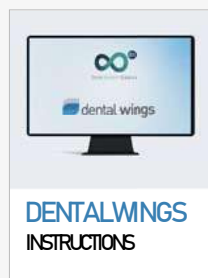

SCANBODY

INTRA/EXTRA-ORAL



UN ÚNICO SCANBODY PARA TODOS LOS USOS.

La línea de Scanbodies desarrollada por el departamento de I+D de Smart Implant Solutions **simplifica enormemente la forma de trabajar.** Sirve tanto para escaneados intraorales (clínica) como para su utilización en modelos de escayola o resina (laboratorio).

1. DIÁMETRO SIMILAR A LA CONEXIÓN
Cada scanbody está fabricado con el mismo diámetro que el implante lo que permite un mejor ajuste a la conexión en boca y evita los problemas con los tejidos blandos.

3. RADIOPACO
Completamente RADIOPACO. Imagen perfecta RX para comprobar el correcto asentamiento en el implante.

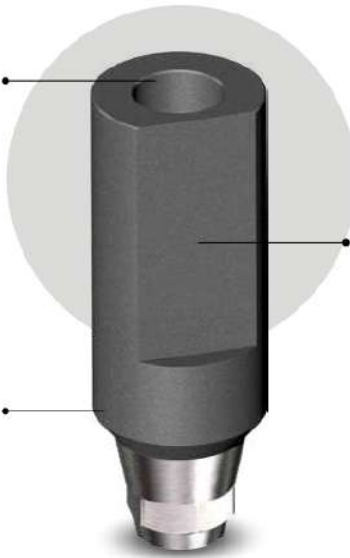

2. AMPLIA CARA PLANA
Amplia cara plana para un mejor best-fit y por consiguiendo una mejor alineación geometría con la conexión.

MÁXIMA PRECISIÓN
en el mecanizado.
(8 micras).



ACABADO ARENADO:
El arenado del scanbody SIS permite que sea leído perfectamente por cualquier escaner del mercado.

MATERIAL:
Cuerpo íntegramente fabricado en Titanio grado 5.



SIMPLIFICA LA MANERA DE TRABAJAR

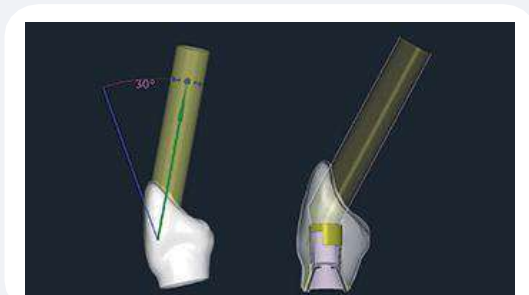
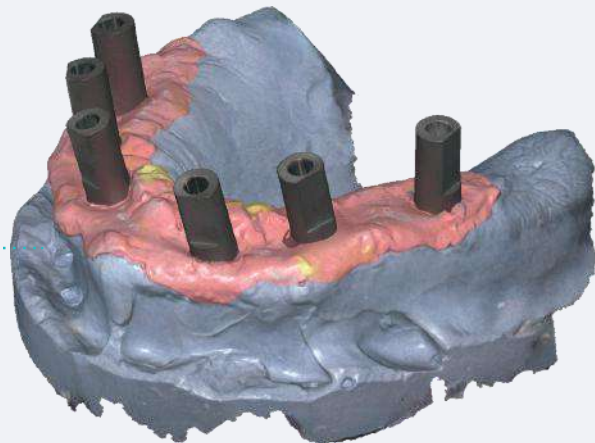
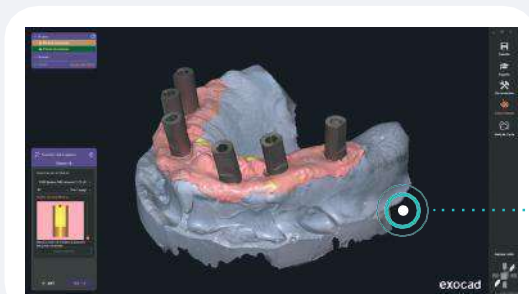

exocad 3shape dental wings



Librerías disponibles para descargar en la página web: www.sisaditamentos.com.mx

ANÁLOGO

DE DOBLE USO, TRADICIONAL Y DIGITAL

El análogo de doble uso desarrollado por el departamento de I+D de Smart Implant Solutions reproduce la conexión del sistema de implantes con una precisión única.



Protocolo.PDF

CALIBRACIÓN DE LA IMPRESORA
Dispone de un protocolo para lograr un ajuste perfecto de los análogos al modelo impreso.

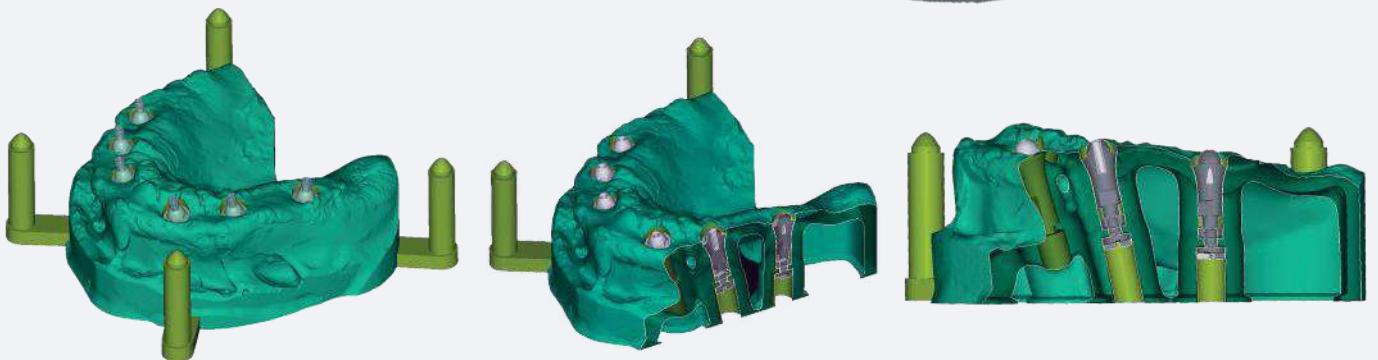
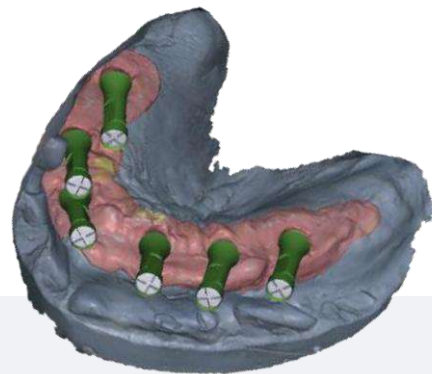

SMART Ti-BASES



**VARIAS
ÁREAS
CEMENTABLES**



ÁREA CÓNICA
Ayuda a la inserción
de los puentes.

**VARIAS
ALTURAS
GINGIVALES**

BIOGOLD
Recubrimiento
de superficie
biocompatible



3 CARAS PLANAS
Evita la rotación
de la prótesis.

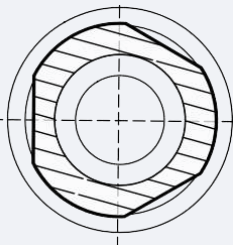

MATERIAL
Titanio Grado 5
(Ti-6Al-4V)
de alta resistencia.

AJUSTE PERFECTO, MEJORADO



Librerías disponibles para
descargar en la pagina web:
www.sisaditamentos.com.mx

exocad

3shape

dental wings

blenderfordental



SMART Ti-BASES CON ALTURA GINGIVAL (HG)



SMART Ti-BASES CON ALTURA GINGIVAL (HG) Y DE CEMENTACIÓN (HC) 7mm.



SMART Ti-BASES RECORTABLE (9mm.)

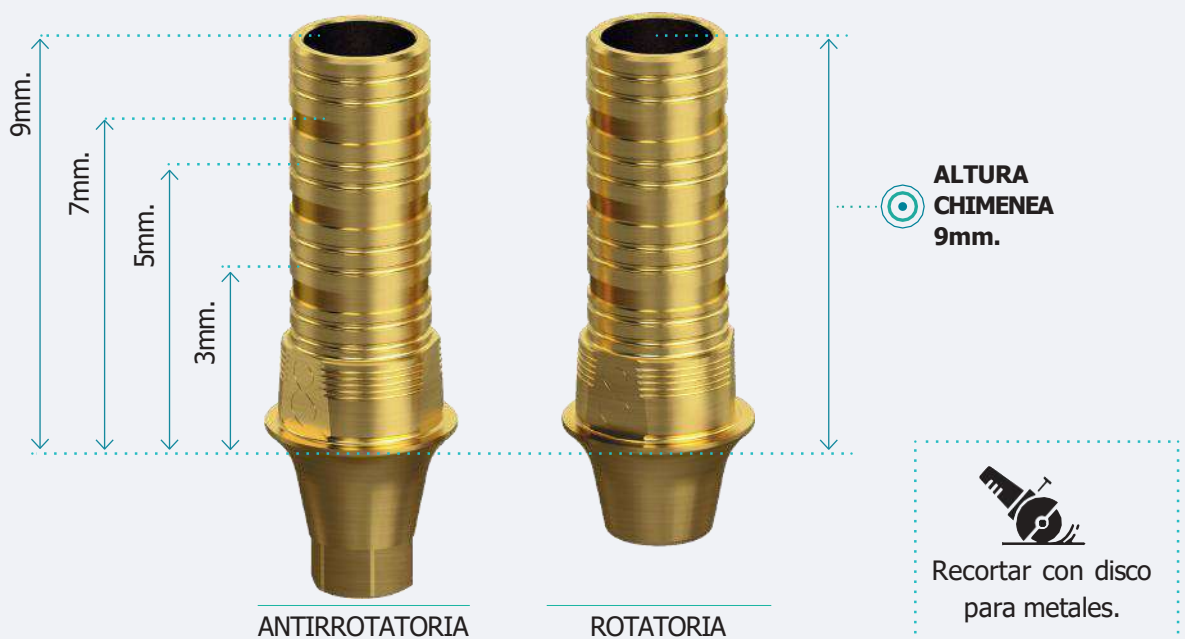

SMART ANGLE



LA SOLUCIÓN ANGULADA MÁS SEGURA DEL MERCADO.



CONEXIÓN MEJORADA:
Evita el coronamiento de los tornillos.

ANODIZADO AZUL:
Permite distinguir un tornillo estandar a un tornillo Smart Angle.

Las Ti-Bases, bases de Cr-Co y las librerías de implantes están preparadas para utilizar la solución angulada Smart Angle.



PATENTE INTERNAL
BALL HEAD - ES 2577509 T3

MATERIAL:
Titanio grado 5.



SMART ANGLE.PDF

CHIMENEAS ANGULADAS PARA BASES DE Cr-Co

Son compatibles con todos nuestros sobrecolables de Cr-Co.



MATERIAL:
Resina
fotopolimerizable
calcinable.



CHIMENEAS.PDF

Compatibilidad con
Ti-BASES CEREC®



compatibilidad con

CEREC®

		Ti-Base Antirrotatoria	Tornillo
ASTRA® TECH OSSEOSPEED® Cónica Interna	Aqua 3.5/4.0	SIS-0512RAC	SIS-0540C
	Lilac 4.5/5.0	SIS-0512WAC	SIS-0541C
NOBEL BIO CARE® BRANEMARK® Hexágono Externo	RP 3.75/4.0	SIS-0112RAC	SIS-0160C
NOBEL BIO CARE® NOBELACTIVE® Interna Activa	NP 3.5/3,75	SIS-0912NAC	SIS-0915C
	RP 4.3/5,0	SIS-0912RAC	SIS-0914C
STRAUMANN® BONE LEVEL® Interna	NC 3.3	SIS-1112NAC	SIS-1104NC
	RC 4.1/4.8	SIS-1112WAC	SIS-1104C
STRAUMANN® TISSUE LEVEL® Octógono	RN 4.8	SIS-0612RAC	SIS-0625C
ZIMMER® SCREW-VENT® Hexágono Interno	NP 3.5	SIS-0312NAC	SIS-0351C
	RP 4.5	SIS-0312RAC	SIS-0351C

Son compatibles con el Scanbody original de CEREC®.

Se venden con el tornillo incluido.



RECUBRIMIENTO: BIOGOLD

MATERIAL: Titanio Grado 5 (Ti-6Al-4V) de alta resistencia.

MULTI-UNIT SIS



EL PILAR TRANSEPITELIAL CREADO POR SMART IMPLANT SOLUTIONS PARA EVITAR LA PERIIMPLANTITIS.

ESTAS SON CUATRO DE SUS MÚLTIPLES CARACTERÍSTICAS:

1. PROTEGE AL IMPLANTE DE LAS BACTERIAS.

Cambio de plataforma (platform switching). El Multi-Unit SIS, es más estrecho que el implante en la zona de conexión para favorecer el apoyo de las fibras de colágeno en el escalón que forma. De esta manera, protege al implante del paso de bacterias con la consiguiente pérdida ósea.

2. EVITA LOS GRISES DE LA ENCÍA.

La superficie del pilar (que conecta con el implante dental) está anodizada, lo que dificulta la colonización bacteriana además de mejorar el aspecto del tejido blando. De esta forma, evitamos los grises en la encía que tanto empeoran la estética dental.

3. MEJORA LA DENSIDAD DEL TEJIDO CONECTIVO.

El hecho de tener microretenciones en la base del pilar, favorece a que las fibras de colágeno se anclen a este y a mejorar la densidad del tejido conectivo.

4. FAVORECE A QUE SE FORMEN FIBRAS DE COLÁGENO ALREDEDOR DEL IMPLANTE.

Este pilar protésico es convergente desde el implante hasta el apoyo de la prótesis dental. De esta manera, favorece a que se formen fibras de colágeno circulares alrededor del implante dental a diferencia de cuando el pilar es recto (en este caso, las fibras de colágeno se disponen de forma paralela al implante). La existencia de fibras de colágeno circulares alrededor del implante, protegen al implante dental haciendo mucho más complicada la colonización por bacterias y por lo tanto la periimplantitis.

**SU MEJOR
ALIADO PARA
EVITAR LA
PERIIMPLANTITIS.**

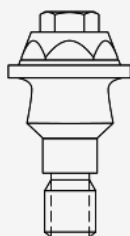

PILAR MULTI-UNIT RECTO
ZIMMER® SCREW-VENT® (NP 3,5) | Hexágono Interno

Alt. 2mm: SIS-0362C

Alt. 3mm: SIS-0363C

Alt. 3mm: SIS-0364C

CONSÚLTENOS SI ESTÁ INTERESADO EN OTRAS CONEXIONES.

MULTI-UNIT ANGULADO

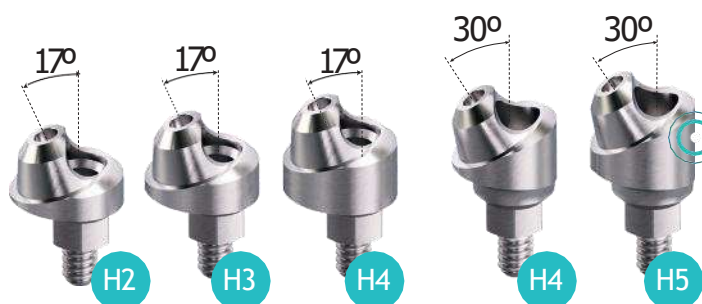

MATERIAL

Titanio Grado 5 (Ti-6Al-4V)
de alta resistencia.

***AJUSTE ÓPTIMO**

(*) AJUSTE ÓPTIMO: El ajuste es óptimo con las llaves Multi-Unit de Smart Implant Solutions (contra-ángulo, carraca, manual...). La rosca de M1,4 está especialmente reforzada asegurando una unión atornillada firme más resistente al torque aplicado.



Todos los pilares
angulados se entregan
montadoAs con su
correspondiente tornillo
y transportador.





MULTI-UNIT Aditamentos

F: 1300

	RP		RP
	SIS-1301		SIS-1390R
	SIS-1316		SIS-1390RA
	SIS-1310	<i>*Tornillos se venden por separado</i>	
	SIS-1302		SIS-1304
	SIS-8888		SIS-1308RA
			SIS-1305
	SIS-1303		SIS-1330RA
	SIS-1308	<i>*Tornillos se venden por separado</i>	
			SIS-9135
	SIS-1313		SIS-9136
	SIS-1306		SIS-8109
	SIS-1311		
	SIS-1307		SIS-2012
	SIS-1307H		
	SIS-1307A		SIS-8207A
			SIS-8207B
	SIS-1307B		
	SIS-1309		
	SIS-1312		
<i>*Tornillos se venden por separado</i>			

*Estos aditamentos NO son compatibles con Multi-Unit ORIGINAL; MIS® SEVEN®, Straumann® (SRA), Paltop®, Megagen Anyridge®.
 *Es requerido adquirir nuestros Multi-Units SiS compatibles para cada una de las marcas mencionadas.

MULTI-UNIT mini



NUEVO PILAR TRANSEPITELIAL DISEÑADO PARA LA LUCHA CONTRA LA PERIIMPLANTITIS GRACIAS A LA MEJORA DEL ESPACIO BIOLÓGICO SUPRACRESTAL

Smart Implant Solutions, junto el Dr. Antonio Romero y la Dra. Macarena Romero, realizaron un estudio basado en múltiples autores como Linkevisius, Michelli, Blanco, Galindo, etc. Concluyeron que las características del pilar transepitelial son cruciales para la estabilidad del hueso periimplantario y el éxito del tratamiento con implantes.

Como resultado, se ha desarrollado el nuevo pilar MULTI-UNIT mini, que ayuda a lograr estos objetivos en el tratamiento con implantes.

mini

DISEÑO ESTRECHO
Mejora la cantidad de fibras de colágeno, incrementando la vascularización del sellado mucoso.

PLATAFORMA REDUCIDA 3,8MM.
Mayor grosor horizontal del tejido alrededor del pilar.

GEOMETRÍA EXTERNA
Convergente hacia coronal. Favorece la migración en esa dirección de los miofibroblastos presentes en el tejido conectivo.

BIOGOLD
Recubrimiento de superficie biocompatible.

MATERIAL
Titanio Grado 5 (Ti-6Al-4V) de alta resistencia.

Alturas desde 1,5mm. hasta 6,5mm.

exocad 3shape

Librerías disponibles para descargar en la pagina web: www.sisaditamentos.com.mx

Sistema MULTI-UNIT mini

	Coping impresión antirrotatorio	ARO-1301NA		Scanbody antirrotatorio	ARO-1390NA
	Análogo	ARO-1302N		Ti-Base antirrotatoria	ARO-1312NA
	Tapón cicatrización	ARO-1303N		Ti-Base rotatoria	ARO-1312NR
	Pilar provisional antirrotatorio	ARO-1350NA		Tornillo Smart Angle	ARO-2012N
	Pilar provisional rotatorio	ARO-1350NR		Llave transportadora Multi-Unit	ARO-9136N
	Tornillo M1,8 (unigrip)	ARO-1307N			

*Estos aditamentos NO son compatibles con Mini Pilar NEODENTE® GM®

Introducción

Se ha observado radiográficamente que pacientes tratados con implantes dentales, habitualmente sufren una temprana pérdida ósea periimplantaria **MBL (MARGINAL BONE LOSS)**. En el transcurso del tiempo las pérdidas óseas son mayores provocando una **alta tasa de enfermedades periimplantarias** a medio y largo plazo, con la posterior **pérdida del implante. (1)**

Aunque pueden ser diferentes factores los que desencadenen el fracaso implantológico, el estudio de múltiples autores como Linkevicius, Michelli, Blanco, Galindo, etc... han demostrado que probablemente, **las características del pilar transepitelial** sean **determinantes en la estabilidad del hueso periimplantario**, y por tanto en el **éxito del tratamiento con implantes. (2)**

La bibliografía actual sugiere que estos pilares deben ser **altos**, y deben dejar el **mayor espacio a su alrededor**, para **aumentar el volumen del tejido blando**.

Smart Implant Solutions junto con el **Dr. Antonio Romero** y la **Dra. Macarena Romero**, basándose en estos estudios, realizan el diseño de un nuevo pilar que contribuye a cumplir esos objetivos en el complejo supracrestal, y por tanto, **mejora los resultados del tratamiento con implantes. (3)**



Diseño

El implante ha sido correctamente colocado dentro del hueso y con suficiente grosor óseo a su alrededor para **evitar los procesos de estrés oxidativo o necrosis avascular. La biología gestiona el cierre en el exterior** para impedir la entrada de las bacterias, responsables como sabemos de los procesos flogóticos periimplantarios.

Esa gestión biológica natural del cierre con el pilar transeptal crea un espacio de aproximadamente **3mm. de altura** tridimensional alrededor del pilar. La naturaleza **no lo puede hacer de otra manera**. Por tanto, deberemos diseñar un pilar, que en **geometría** y en **altura**, permita al organismo generar ese complejo biológico supracrestal. **(4)**

1. GEOMETRÍA EXTERNA:

Atendiendo a la geometría externa, el pilar ideal debería ser **convergente hacia coronal** para favorecer la migración en esa dirección de los miofibroblastos presentes en el tejido conectivo. **(5)**

2. ALTURA MÍNIMA:

En cuanto a la altura, debería permitirnos tener al menos esos **3mm.** para la creación del **espacio biológico natural**. Esto, en muchos casos, solo se podría conseguir con una colocación subcrestal del implante, o con incrementos de tejido blando. En resumen, **grosor** de esa mucosa que permita su buena vascularización, lo que nos asegura su **estabilidad** a largo plazo. **(6)**

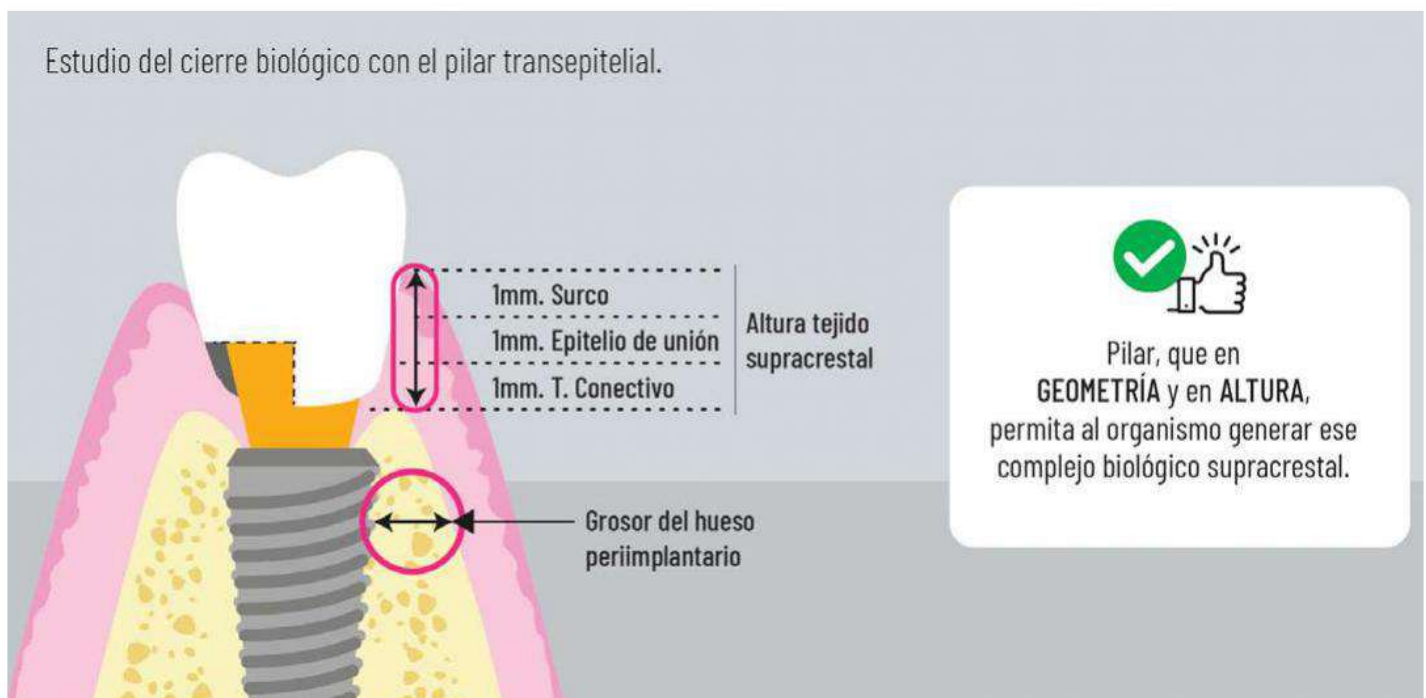

Estudio del cierre biológico con el pilar transepitelial.

1. GEOMETRÍA EXTERNA

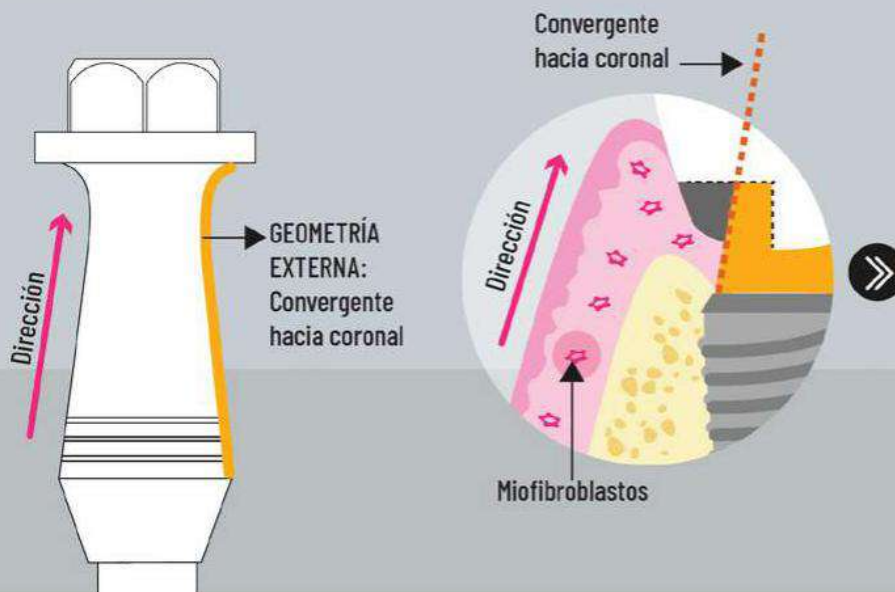

Favorece la migración en esa dirección de los miofibroblastos.

Estudio del cierre biológico con el pilar transepitelial.

2. ALTURA MÍNIMA

GROSOR de la mucosa.



BUENA vascularización.



ESTABILIDAD A LARGO PLAZO.

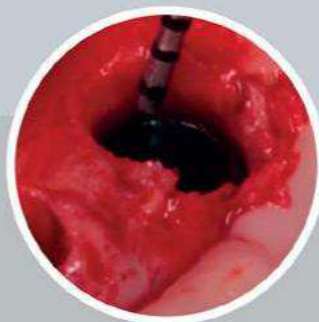
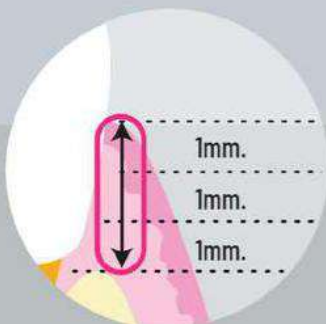

Características

ALTURA Y CONVERGENCIA :

Fabricado en alturas mayores de los habituales en el mercado, atendiendo a la marcada tendencia de **colocación subcrestal**, así llegamos **hasta los 6,5mm. (7)**

PLATAFORMA DE 3,8mm.: Tiene una plataforma de 3,8mm. de diámetro frente a los 4.8mm. del multi-unit universal.

Esta condición aumenta de forma evidente **el grosor horizontal** (mejoramos dimensionalmente el espacio biológico horizontal) **del tejido alrededor del pilar. (8)**

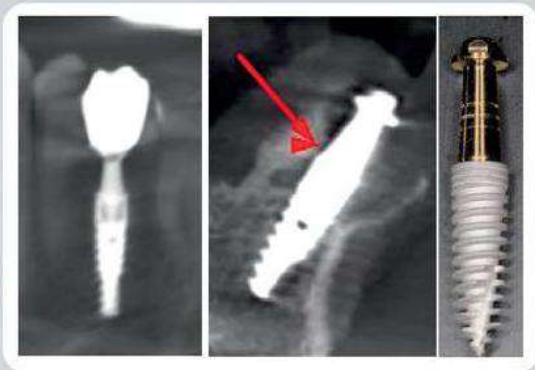

ALTURAS MAYORES
Desde 1,5mm. a 6,5mm.



MULTI-UNIT mini



MULTI-UNIT UNIVERSAL
Plataforma de 4,8mm.



MULTI-UNIT mini
Plataforma de 3,8mm.



PLATAFORMA DE
3,8mm.

Mayor grosor horizontal del
tejido alrededor del pilar.

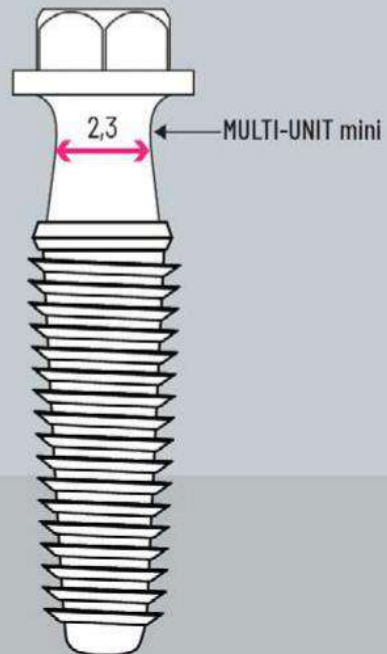
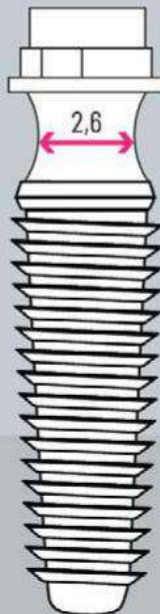
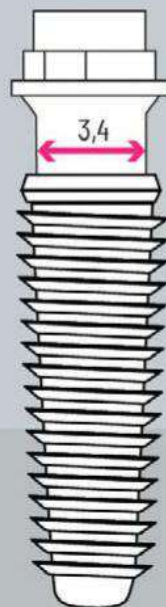

SIScator/Locator®

RECUBRIMIENTO
BIOGOLD

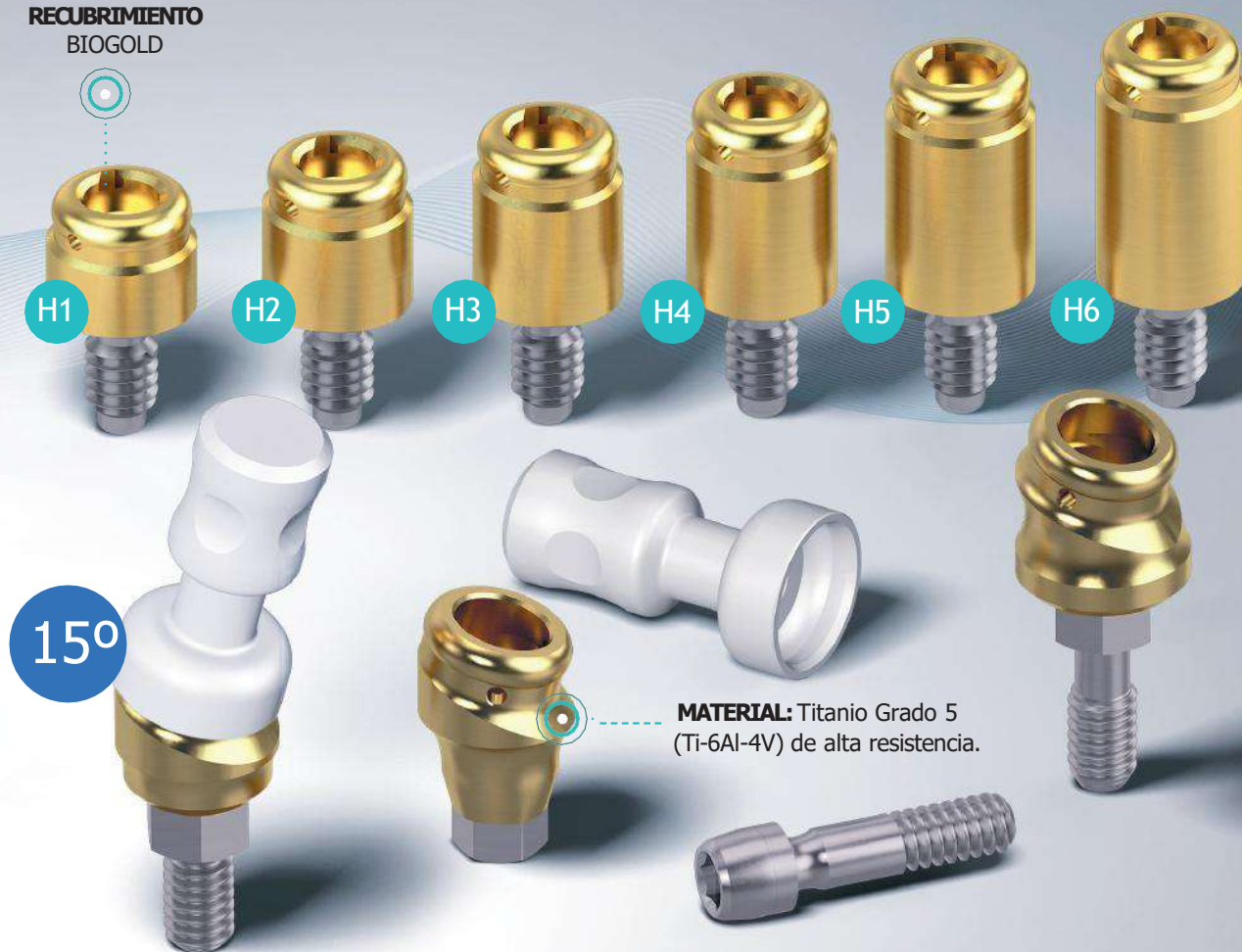

PILAR SIScator Y SiScator ANGULADO 15° CREADO POR SMART IMPLANT SOLUTIONS









CARACTERÍSTICAS PILAR SIScator ANGULADO 15°

- **Alturas disponibles:** 1,5 mm y 3 mm.
 - **Zona gingival optimizada:** diseño anatómico que evita grosores excesivos y aristas, favoreciendo la adaptación natural del tejido blando.
 - **Altura mesial/distal exacta:** control dimensional milimétrico que garantiza uniformidad y precisión una vez colocado.
 - **Transportador:** evita marcas o desgastes del pilar durante la colocación.
 - **Función paralelizadora:** el transportador permite verificar la correcta verticalidad del pilar durante la colocación intraoral.
 - **Conexión micromilimétrica:** ajuste perfecto entre implante y pilar, asegurando estabilidad y sellado óptimo.
 - **Compatibilidad:** funciona con hembras SIScator estándar (rectas y divergentes).
 - **Tornillos compatibles:** apta para conexiones originales (mismo destornillador y asentamiento).
 - **Diseño ergonómico y funcional:** pensado para optimizar tiempos, mejorar la precisión y ofrecer una experiencia de uso superior.
-
- **Pilar, tornillo y transportador** suministrados conjuntamente, garantizando mayor seguridad y comodidad en clínica.
-



Se recomienda su uso con toda nuestra gama de productos compatibles para SIScator.

SiScator / Locator®

		SiScator
	<p>Pack de procesamiento Botón de retención estándar transparente, light rosa, extralight azul, angulado 20° ret. extralight rojo. Botón procesado negro, arandela espaciadora, cápsula metálica.</p>	SIS-8101S
 <p>(1) (2)</p>	Botón ret. estándar transparente (4 uds.)	SIS-8106S
	Botón ret. light rosa (4 uds.)	SIS-8107S
	Botón ret. extralight azul (4 uds.)	SIS-8108S
	Botón angulado 20° ret. estándar verde (4 uds.)	SIS-8102S
	Botón angulado 20° ret. light naranja (4 uds.)	SIS-8114S
	Botón angulado 20° ret. extralight rojo (4 uds.)	SIS-8103S
	Botón procesado negro (4 uds.)	SIS-8113S
	Arandela espaciadora (4 uds.) (1)	SIS-8115S
Cápsula metálica (4 uds.) (2)	SIS-8112S	
	Llave SiScator Core Tool	SIS-9146
 <p>(3) (4) (5)</p>	Análogo pilar SiScator (3)	SIS-8104
	Transportador pilar SiScator (4)	SIS-8105
	Coping de impresión pilar SiScator (5) + botón negro	SIS-8111
 <p>(6) (7)</p>	Llave carraca SiScator (6)	SIS-9113
	Llave contraángulo SiScator (7)	SIS-9134
 <p>(8) (9)</p>	Calcinable roscado para SiScator barra (8)	SIS-8116
	Pilar SiScator barra (9)	SIS-8117
	<p>SiScator para Multi-Unit Permite corregir discrepancias en las angulaciones entre implantes de hasta 70°. Es compatible con todos los Multi-Unit de Smart Implant Solutions rectos y angulados.</p>	SIS-8109
	<p>SiScator de Cr-Co Anclaje resiliente para sobredentaduras sobre implantes ferulizados con barras. El SiScator de Cr-Co permite tanto su uso para soldar sobre barras coladas o fresadas como su sobrecolado.</p>	SIS-8110

BIOCARB^B



RECUBRIMIENTO DE SUPERFICIE BIOCOMPATIBLE



Tratamiento con carburo de tungsteno que le confiere las mismas propiedades que el oro en cuanto a pretensión y resistencia a la fatiga.

UNA CORONA PARA TODA LA VIDA.

Cuando la corona comienza a moverse y a soltarse del implante de forma lenta pero continua, debe llevarse a cabo una nueva operación que implica ciertos riesgos.

Con BIOCARB puede estar tranquilo, el torque sobre el tornillo se reduce y al mismo tiempo los tornillos del implante recubiertos tienen un 30% mejor par de apriete.

- Recubrimiento multicapa de carbono amorfo.
- Elevada tenacidad y dureza (2000-5000HV).
- Acabado color gris.
- Totalmente hemo y biocompatible al basarse en el carbono.
- Esterilizable.
- Alta resistencia al desgaste.
- Mejor ajuste del tornillo.
- Reducción del torque aplicado sobre el tornillo.
- Los tornillos del implante pueden quitarse sin riesgo de roturas o agarrotamiento.

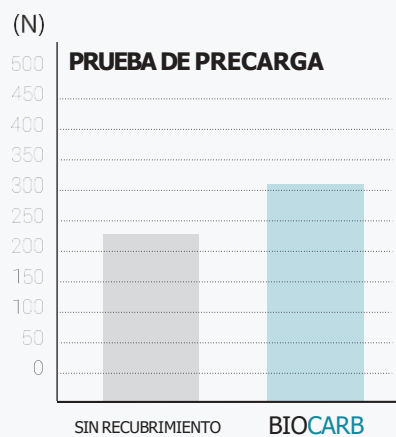

Ensayos.pdf

BIOGOLD[®]



RECUBRIMIENTO DE SUPERFICIE BIOCOMPATIBLE



Ofrece una serie de ventajas como su alta resistencia a la corrosión durante la esterilización y un estético color amarillo dorado, evitando zonas grises en biotopos gingivales finos.

MÁXIMA HIGIENE Y SEGURIDAD.

Las Smart Ti-Bases, los pilares Multi-Unit, pilares SIScator, pilares rectos y angulados son tratados con el recubrimiento BIOGOLD, mejorando su rendimiento.

Este tratamiento ofrece mayor resistencia a la fatiga, evita la liberación de iones (ion leaching) y reduce la actividad bacteriana evitando que se adhieran restos orgánicos.

DISPONE DE LOS SIGUIENTES TEST Y CERTIFICACIONES:

- **CITOTOXICIDAD**
- **SENSIBILIZACIÓN CUTÁNEA**
- **IRRITACIÓN**



Citotoxicidad.pdf



Sensibilización.pdf



Irritación.pdf

TAPONES DE CICATRIZACIÓN



DISPONIBLES EN VARIAS ALTURAS
PARA CADA SISTEMA DE IMPLANTES

MARCADO LASER
Para rápida identificación
de la altura gingival.



PULIDO ESPEJO
Evita la adhesión de
placa bacteriana.











MATERIAL
Titanio Grado 5 (Ti-6Al-4V)
de alta resistencia.



CATÁLOGO GENERAL CONEXIONES

THINK DIGITAL



	NP 3.3	RP 3.75/4.0	WP 5.0
	Pilar SISCator alt. 0.73mm SIS-0117N	SIS-0117	
	Pilar SISCator alt. 1mm		SIS-0117W
	Pilar SISCator alt. 2mm	SIS-0118	SIS-0118W
	Pilar SISCator alt. 3mm	SIS-0119	SIS-0119W
	Pilar SISCator alt. 4mm	SIS-0158	SIS-0158W
	Pilar SISCator alt. 5mm	SIS-0159	SIS-0159W
	Pilar SISCator alt. 6mm	SIS-0163	
	Pilar SISCator angulado 15° alt. 1,5mm	SIS-0117H1N	SIS-0117H1R
	Pilar SISCator angulado 15° alt. 3mm	SIS-0117H3N	SIS-0117H3R
	Tornillo M1,6 (unigrip) SIS-0915		
	Tornillo M2 (hex. 1,20)	SIS-0152	
	Tornillo M2 (hex. 1,25)	SIS-0153	
	Tornillo M2 (hex. 1,20) rosca completa	SIS-0160	
	Tornillo M2 (hex. 1,25) rosca completa	SIS-0161	
	Tornillo M2 (unigrip)	SIS-0151	
	Tornillo M2 (cuadrado 1,30)	SIS-0154	
	Tornillo M2,5 (hex. 1,20)		SIS-0156
	TORNILLOS CON RECUBRIMIENTO BIOCARB		
	Tornillo M1,6 (unigrip) SIS-0915B		
	Tornillo M2 (hex. 1,20)	SIS-0152B	
	Tornillo M2 (hex. 1,25)	SIS-0153B	
	Tornillo M2 (hex. 1,20) rosca completa	SIS-0160B	
	Tornillo M2 (hex. 1,25) rosca completa	SIS-0161B	
	Tornillo M2 (unigrip)	SIS-0151B	
	Tornillo M2 (cuadrado 1,30)	SIS-0154B	
	Tornillo M2,5 (hex. 1,20)		SIS-0156B
	MULTI-UNIT SIS		
	Pilar Multi-Unit recto alt. 1mm SIS-0160NH0C	SIS-0160RH0C	
	Pilar Multi-Unit recto alt. 1,5mm	SIS-0165C	SIS-0168C
	Pilar Multi-Unit recto alt. 2,5mm	SIS-0166C	SIS-0169C
	Pilar Multi-Unit recto alt. 3,5mm	SIS-0167C	SIS-0170C
	Pilar Multi-Unit recto alt. 4,5mm		SIS-0171C
	Pilar Multi-Unit recto alt. 5,5mm		SIS-0172C
	Pilar Multi-Unit angul. 17° alt. 2mm		SIS-0176
	Pilar Multi-Unit angul. 17° alt. 3mm		SIS-0177
	Pilar Multi-Unit angul. 17° alt. 4mm		SIS-0178
	Pilar Multi-Unit angul. 30° alt. 3mm		SIS-0179
	Pilar Multi-Unit angul. 30° alt. 4mm		SIS-0180
	Pilar Multi-Unit angul. 30° alt. 5mm		SIS-0181
	Unigrip		
	IMPLANTES ZIGOMÁTICOS		
	Pilar Multi-Unit recto alt. 1mm		SIS-0168Z
	Pilar Multi-Unit recto alt. 2mm		SIS-0169Z
	SMART ANGLE		
	Tornillo Smart Angle	SIS-2002	SIS-2001
	Tornillo Smart Angle alt. 3mm/4mm	SIS-2002HG	SIS-2001HG
	CALCINABLE ANGULADA PARA BASES DE Cr-Co		
	Chimenea ang. 17°	SIS-8207A	SIS-8207A
	Chimenea ang. 30°	SIS-8207B	SIS-8207B



BIOMET 3I® OSSEOTITE®

Hexágono Externo



Coping impresión (cubeta abierta)

Coping impresión (cubeta cerrada)

Hexagonal 1,20

NP 3.4

SIS-0201N

RP 4.1

SIS-0101

SIS-0101C

WP 5.0

SIS-0201W



Análogo

Tornillo fijación análogo digital

Plana/Cruz

SIS-0201

SIS-8888

SIS-0102

SIS-8888

SIS-0216

SIS-8888



Tapón cicatrización alt. 2mm

Tapón cicatrización alt. 3mm

Tapón cicatrización alt. 4mm

Tapón cicatrización alt. 5mm

Tapón cicatrización alt. 6mm

Hexagonal 1,20/Plana

SIS-0104

SIS-0105

SIS-0106

SIS-0107

SIS-0108



Pilar recto rotatorio

Pilar recto antirrotatorio

Pilar angulado 15°

Pilar angulado 25°

Pilar provisional rotatorio

Pilar provisional antirrotatorio

**Tornillos se venden por separado*

SIS-0205NA

SIS-0188R

SIS-0109

SIS-0182

SIS-0183

SIS-0162

SIS-0164

SIS-0205WA

SMART
TI-BASE



Ti-Base rotatoria

Ti-Base antirrotatoria

SIS-0208NR

SIS-0208NA

SIS-0108RR

SIS-0108RA

SIS-0208WR

SIS-0208WA



Ti-Base HG 2mm rotatoria

Ti-Base HG 2mm antirrotatoria

Ti-Base HG 3mm rotatoria

Ti-Base HG 3mm antirrotatoria

SIS-0108RRG2

SIS-0108RAG2

SIS-0108RRG3

SIS-0108RAG3



Ti-Base HC 7mm rotatoria

Ti-Base HC 7mm antirrotatoria

SIS-0108RRC7

SIS-0108RAC7



Ti-Base HG 2mm HC 7mm rotatoria

Ti-Base HG 2mm HC 7mm antirrotatoria

Ti-Base HG 3mm HC 7mm rotatoria

Ti-Base HG 3mm HC 7mm antirrotatoria

SIS-0108RRG2C7

SIS-0108RAG2C7

SIS-0108RRG3C7

SIS-0108RAG3C7



Ti-Base HC 9mm rotatoria (recortable)

Ti-Base HC 9mm antirrotatoria (recortable)

**Tornillos se venden por separado*

SIS-0208NRC9

SIS-0208NAC9

SIS-0108RRC9

SIS-0108RAC9

SIS-0208WRC9

SIS-0208WAC9



Scanbody (Ti)

**Tornillos se venden por separado*

SIS-0290N

SIS-0190R

SIS-0290W



Calcinable rotatorio

Calcinable antirrotatorio

Sobrecolable Cr-Co rotatorio

Sobrecolable Cr-Co antirrotatorio

**Tornillos se venden por separado*

SIS-0209

SIS-0210

SIS-0230NR

SIS-0230NA

SIS-0110

SIS-0111

SIS-0114

SIS-0115

SIS-0224

SIS-0225

SIS-0230WR

SIS-0230WA



BIOMET 3I® OSSEOTITE®

Hexágono Externo

		NP 3.4	RP 4.1	WP 5.0
	Pilar SISCator alt. 0,73mm		SIS-0117	SIS-0117
	Pilar SISCator alt. 2mm		SIS-0118	SIS-0118
	Pilar SISCator alt. 3mm		SIS-0119	SIS-0119
	Pilar SISCator alt. 4mm		SIS-0158	SIS-0158
	Pilar SISCator alt. 5mm		SIS-0159	SIS-0159
	Pilar SISCator alt. 6mm		SIS-0163	SIS-0163
	Pilar SISCator angulado 15° alt. 1,5mm.		SIS-0117H1R	
	Pilar SISCator angulado 15° alt. 3mm.		SIS-0117H3R	
	Tornillo M2 (hex. 1,20)	SIS-0152	SIS-0152	SIS-0152
	Tornillo M2 (hex. 1,25)	SIS-0153	SIS-0153	SIS-0153
	Tornillo M2 (hex. 1,20) rosca completa	SIS-0160	SIS-0160	SIS-0160
	Tornillo M2 (hex. 1,25) rosca completa	SIS-0161	SIS-0161	SIS-0161
	Tornillo M2 (unigrip)	SIS-0151	SIS-0151	SIS-0151
	Tornillo M2 (cuadrado 1,30)	SIS-0154	SIS-0154	SIS-0154
B TORNILLOS CON RECUBRIMIENTO BIOCARB				
	Tornillo M2 (hex. 1,20)	SIS-0152B	SIS-0152B	SIS-0152B
	Tornillo M2 (hex. 1,25)	SIS-0153B	SIS-0153B	SIS-0153B
	Tornillo M2 (hex. 1,20) rosca completa	SIS-0160B	SIS-0160B	SIS-0160B
	Tornillo M2 (hex. 1,25) rosca completa	SIS-0161B	SIS-0161B	SIS-0161B
	Tornillo M2 (unigrip)	SIS-0151B	SIS-0151B	SIS-0151B
	Tornillo M2 (cuadrado 1,30)	SIS-0154B	SIS-0154B	SIS-0154B
SIS MULTI-UNIT SIS				
	Pilar Multi-Unit recto alt. 1mm		SIS-0160RH0C	
	Pilar Multi-Unit recto alt. 1,5mm		SIS-0168C	
	Pilar Multi-Unit recto alt. 2,5mm		SIS-0169C	
	Pilar Multi-Unit recto alt. 3,5mm		SIS-0170C	
	Pilar Multi-Unit recto alt. 4,5mm		SIS-0171C	
	Pilar Multi-Unit recto alt. 5,5mm		SIS-0172C	
	Pilar Multi-Unit angul. 17° alt. 2mm		SIS-0176	
	Pilar Multi-Unit angul. 17° alt. 3mm		SIS-0177	
	Pilar Multi-Unit angul. 17° alt. 4mm		SIS-0178	
	Pilar Multi-Unit angul. 30° alt. 3mm		SIS-0179	
	Pilar Multi-Unit angul. 30° alt. 4mm		SIS-0180	
	Pilar Multi-Unit angul. 30° alt. 5mm		SIS-0181	
Unigrip				
SMART ANGLE				
	Tornillo Smart Angle	SIS-2028	SIS-2028	SIS-2028
	Tornillo Smart Angle alt. 3mm/4mm		SIS-2001HG	
CALCINABLE ANGULADA PARA BASES DE Cr-Co				
	Chimenea ang. 17°	SIS-8207A	SIS-8207A	SIS-8207A
	Chimenea ang. 30°	SIS-8207B	SIS-8207B	SIS-8207B

F: 0200/0100



MIS® SEVEN®

Hexágono Interno

NP 3.30

SP 3.75/4.20

WP 5.0/6.0



Coping impresión (cubeta abierta)
Hexagonal 1,27

SIS-0301X

SIS-0320

SIS-0301



Análogo
Tornillo fijación análogo digital
Plana/Cruz

SIS-0302X

SIS-0321

SIS-0302

SIS-8888

SIS-8888

SIS-8888



Tapón cicatrización alt. 2mm

SIS-0304X

SIS-0323

SIS-0304

Tapón cicatrización alt. 3mm

SIS-0305X

SIS-0324

SIS-0305

Tapón cicatrización alt. 4mm

SIS-0306X

SIS-0325

SIS-0306

Tapón cicatrización alt. 5mm

SIS-0307X

SIS-0326

SIS-0307

Tapón cicatrización alt. 6mm

SIS-0327

Hexagonal 1,27



Pilar recto antirrotatorio alt. 0mm

SIS-0305XA

SIS-0328H0

SIS-0309H0

Pilar recto antirrotatorio alt. 1mm

SIS-0328H1

SIS-0309H1

Pilar recto antirrotatorio alt. 2mm

SIS-0328H2

SIS-0309H2

Pilar recto antirrotatorio alt. 3mm

SIS-0328H3

SIS-0309H3



Pilar angulado 15°

SIS-0382

SIS-0382R

Pilar angulado 25°

SIS-0383

SIS-0383R

Pilar provisional rotatorio

SIS-0380X

SIS-0380

SIS-0350RR

Pilar provisional antirrotatorio

SIS-0381X

SIS-0381

SIS-0350RA

*Tornillos se venden por separado

SMART
TI-BASE



Ti-Base rotatoria

SIS-0308XR

SIS-0308NR

SIS-0308RR

Ti-Base antirrotatoria

SIS-0308XA

SIS-0308NA

SIS-0308RA



Ti-Base HG 2mm rotatoria

SIS-0308XRG2

SIS-0308NRG2

Ti-Base HG 2mm antirrotatoria

SIS-0308XAG2

SIS-0308NAG2



Ti-Base HG 3mm rotatoria

SIS-0308XRG3

SIS-0308NRG3

Ti-Base HG 3mm antirrotatoria

SIS-0308XAG3

SIS-0308NAG3



Ti-Base HG 4mm rotatoria

SIS-0308XRG4

SIS-0308NRG4

Ti-Base HG 4mm antirrotatoria

SIS-0308XAG4

SIS-0308NAG4



Ti-Base HC 7mm rotatoria

SIS-0308XRC7

SIS-0308NRC7

Ti-Base HC 7mm antirrotatoria

SIS-0308XAC7

SIS-0308NAC7



Ti-Base HG 2mm HC 7mm rotatoria

SIS-0308XRG2C7

SIS-0308NRG2C7

Ti-Base HG 2mm HC 7mm antirrotatoria

SIS-0308XAG2C7

SIS-0308NAG2C7



Ti-Base HG 3mm HC 7mm rotatoria

SIS-0308XRG3C7

SIS-0308NRG3C7

Ti-Base HG 3mm HC 7mm antirrotatoria

SIS-0308XAG3C7

SIS-0308NAG3C7



Ti-Base HG 4mm HC 7mm rotatoria

SIS-0308XRG4C7

SIS-0308NRG4C7

Ti-Base HG 4mm HC 7mm antirrotatoria

SIS-0308XAG4C7

SIS-0308NAG4C7



Ti-Base HC 9mm rotatoria (recortable)

SIS-0308XRC9

SIS-0308NRC9

SIS-0308RRC9

Ti-Base HC 9mm antirrotatoria (recortable)

SIS-0308XAC9

SIS-0308NAC9

SIS-0308RAC9

*Tornillos se venden por separado

Scanbody (Ti)

SIS-0390X

SIS-0390N

SIS-0390R

*Tornillos se venden por separado

Calcinable rotatorio

SIS-0310X

SIS-0329

SIS-0310

Calcinable antirrotatorio

SIS-0311X

SIS-0330

SIS-0311

Sobrecolable Cr-Co rotatorio

SIS-0314X

SIS-0333

SIS-0314

Sobrecolable Cr-Co
antirrotatorio

SIS-0315X

SIS-0334

SIS-0315

*Tornillos se venden por separado



MIS® SEVEN®

Hexágono Interno

	NP 3.30	SP 3.75/4.20	WP 5.0/6.0	
	Pilar SISCator alt. 1mm	SIS-0317X	SIS-0353	SIS-0317
	Pilar SISCator alt. 2mm	SIS-0318X	SIS-0354	SIS-0318
	Pilar SISCator alt. 3mm	SIS-0319X	SIS-0355	SIS-0319
	Pilar SISCator alt. 4mm	SIS-0352X	SIS-0356	SIS-0352
	Pilar SISCator alt. 5mm	SIS-0358X	SIS-0357	SIS-0358
	Pilar SISCator alt. 6mm	SIS-0360X	SIS-0359	SIS-0360
	Pilar SISCator angulado 15° alt. 1,5mm.		SIS-0317H1N	SIS-0317H1R
	Pilar SISCator angulado 15° alt. 3mm.		SIS-0317H3N	SIS-0317H3R
	Tornillo M1,6 (hex. 1,27)	SIS-0351MX		
	Tornillo UNF 1/72 (hex. 1,25)		SIS-0351M	SIS-0351M
	TORNILLOS CON RECUBRIMIENTO BIOCARB			
	Tornillo M1,6 (hex. 1,27)	SIS-0351MXB		
	Tornillo UNF 1/72 (hex. 1,25)		SIS-0351MB	SIS-0351MB
	SIS MULTI-UNIT			
	Pilar Multi Unit recto alt. 0,9mm.	SIS-0360XH0C	SIS-0360NH0C	SIS-0360RH0C
	Pilar Multi-Unit recto alt. 1,5mm	SIS-0366XC	SIS-0361C	SIS-0366C
	Pilar Multi-Unit recto alt. 2,5mm	SIS-0367XC	SIS-0362C	SIS-0367C
	Pilar Multi-Unit recto alt. 3,5mm	SIS-0368XC	SIS-0363C	SIS-0368C
	Pilar Multi-Unit recto alt. 4,5mm	SIS-0369XC	SIS-0364C	SIS-0369C
	Pilar Multi-Unit recto alt. 5,5mm	SIS-0360XH5C	SIS-0365C	SIS-0370C
	Pilar Multi-Unit recto alt. 6,5mm	SIS-0360XH6C	SIS-0360NH6C	SIS-0360RH6C
	mini MULTI-UNIT mini			
	Pilar Multi-Unit recto alt. 1,5mm	ARO-0380XH1	ARO-0380NH1	
	Pilar Multi-Unit recto alt. 2,5mm	ARO-0380XH2	ARO-0380NH2	
	Pilar Multi-Unit recto alt. 3,5mm	ARO-0380XH3	ARO-0380NH3	
	Pilar Multi-Unit recto alt. 4,5mm	ARO-0380XH4	ARO-0380NH4	
	Pilar Multi-Unit recto alt. 5,5mm	ARO-0380XH5	ARO-0380NH5	
	Pilar Multi-Unit angul. 17° alt. 2,5mm	SIS-0370XH25		
	Pilar Multi-Unit angul. 17° alt. 3,5mm	SIS-0370XH35		
	Pilar Multi-Unit angul. 30° alt. 3,5mm	SIS-0371XH35		
	Pilar Multi-Unit angul. 30° alt. 4,5mm	SIS-0371XH45		
	Pilar Multi-Unit angul. 17° alt. 2mm		SIS-0371	
	Pilar Multi-Unit angul. 17° alt. 3mm		SIS-0372	SIS-0376
	Pilar Multi-Unit angul. 17° alt. 4mm		SIS-0373	SIS-0377
	Pilar Multi-Unit angul. 30° alt. 4mm		SIS-0374	SIS-0378
	Pilar Multi-Unit angul. 30° alt. 5mm		SIS-0375	SIS-0379
		Hexagonal 1,27		
	SMART ANGLE			
	Tornillo Smart Angle	SIS-2025	SIS-2007M	SIS-2007M
	Tornillo Smart Angle alt. 3mm/4mm	SIS-2025HG	SIS-2007MHG	
	CALCINABLE ANGULADA PARA BASES DE Cr-Co			
	Chimenea ang. 17°	SIS-8207A	SIS-8207A	SIS-8207A
	Chimenea ang. 30°	SIS-8207B	SIS-8207B	SIS-8207B

F: 0160



ZIMMER® SCREW-VENT®

Hexágono Interno

	NP 3.5	RP 4.5	WP 5.7
--	--------	--------	--------



Coping impresión (cubeta abierta)

Hexagonal 1,27

SIS-0320

SIS-0301

SIS-0336



Análogo

Tornillo fijación análogo digital

Plana/Cruz

SIS-0321

SIS-0302

SIS-0337

SIS-8888

SIS-8888

SIS-8888



Tapón cicatrización alt. 2mm

Tapón cicatrización alt. 3mm

Tapón cicatrización alt. 4mm

Tapón cicatrización alt. 5mm

Tapón cicatrización alt. 6mm

Hexagonal 1,27

SIS-0323

SIS-0304

SIS-0324

SIS-0305

SIS-0325

SIS-0306

SIS-0326

SIS-0307

SIS-0327



Pilar recto antirrotatorio alt. 0mm

Pilar recto antirrotatorio alt. 1mm

Pilar recto antirrotatorio alt. 2mm

Pilar recto antirrotatorio alt. 3mm



Pilar angulado 15°

Pilar angulado 25°

Pilar provisional rotatorio

Pilar provisional antirrotatorio

*Tornillos se venden por separado

SIS-0328H0Z

SIS-0309H0Z

SIS-0305WAZ

SIS-0328H1Z

SIS-0309H1Z

SIS-0328H2Z

SIS-0309H2Z

SIS-0328H3Z

SIS-0309H3Z

SIS-0382Z

SIS-0383Z

SIS-0380Z

SIS-0350RRZ

SIS-0381Z

SIS-0350RAZ

SMART
Ti-BASE



Ti-Base rotatoria

Ti-Base antirrotatoria



Ti-Base HG 2mm rotatoria

Ti-Base HG 2mm antirrotatoria



Ti-Base HG 3mm rotatoria

Ti-Base HG 3mm antirrotatoria



Ti-Base HG 4mm rotatoria

Ti-Base HG 4mm antirrotatoria



Ti-Base HC 7mm rotatoria

Ti-Base HC 7mm antirrotatoria



Ti-Base HG 2mm HC 7mm rotatoria

Ti-Base HG 2mm HC 7mm antirrotatoria



Ti-Base HG 3mm HC 7mm rotatoria

Ti-Base HG 3mm HC 7mm antirrotatoria



Ti-Base HG 4mm HC 7mm rotatoria

Ti-Base HG 4mm HC 7mm antirrotatoria



Ti-Base HC 9mm rotatoria (recortable)

Ti-Base HC 9mm antirrotatoria (recortable)

*Tornillos se venden por separado

SIS-0308NRZ

SIS-0308RRZ

SIS-0308WRZ

SIS-0308NAZ

SIS-0308RAZ

SIS-0308WAZ

SIS-0308NRG2Z

SIS-0308RRG2Z

SIS-0308NAG2Z

SIS-0308RAG2Z

SIS-0308NRG3Z

SIS-0308RRG3Z

SIS-0308NAG3Z

SIS-0308RAG3Z

SIS-0308NRG4Z

SIS-0308RRG4Z

SIS-0308NAG4Z

SIS-0308RAG4Z

SIS-0308NRC7Z

SIS-0308RRC7Z

SIS-0308NAC7Z

SIS-0308RAC7Z

SIS-0308NRG2C7Z

SIS-0308RRG2C7Z

SIS-0308NAG2C7Z

SIS-0308RAG2C7Z

SIS-0308NRG3C7Z

SIS-0308RRG3C7Z

SIS-0308NAG3C7Z

SIS-0308RAG3C7Z

SIS-0308NRG4C7Z

SIS-0308RRG4C7Z

SIS-0308NAG4C7Z

SIS-0308RAG4C7Z

SIS-0308NRC9Z

SIS-0308RRC9Z

SIS-0308WRC9Z

SIS-0308NAC9Z

SIS-0308RAC9Z

SIS-0308WAC9Z



Scanbody (Ti)

*Tornillos se venden por separado

SIS-0390NZ

SIS-0390RZ

SIS-0390WZ



Sobrecolable Cr-Co rotatorio

Sobrecolable Cr-Co antirrotatorio

*Tornillos se venden por separado

SIS-0333Z

SIS-0314Z

SIS-0334Z

SIS-0315Z



ZIMMER® SCREW-VENT®

Hexágono Interno

		NP 3.5	RP 4.5	WP 5.7
	Pilar SIScator alt. 1mm	SIS-0353	SIS-0317	SIS-0317W
	Pilar SIScator alt. 2mm	SIS-0354	SIS-0318	SIS-0318 W
	Pilar SIScator alt. 3mm	SIS-0355	SIS-0319	SIS-0319 W
	Pilar SIScator alt. 4mm	SIS-0356	SIS-0352	SIS-0352 W
	Pilar SIScator alt. 5mm	SIS-0357	SIS-0358	SIS-0358 W
	Pilar SIScator alt. 6mm	SIS-0359	SIS-0360	
	Pilar SIScator angulado 15° alt. 1,5mm.	SIS-0317H1NZ	SIS-0317H1RZ	
	Pilar SIScator angulado 15° alt. 3mm.	SIS-0317H3NZ	SIS-0317H3RZ	
	Tornillo UNF 1/72 (hex. 1,27)	SIS-0351Z	SIS-0351Z	SIS-0351Z
	B TORNILLOS CON RECUBRIMIENTO BIOCARB Tornillo UNF 1/72 (hex. 1,27)	SIS-0351ZB	SIS-0351ZB	SIS-0351ZB
	SIS MULTI-UNIT SIS Pilar Multi-Unit recto alt. 0,9mm	SIS-0360NH0ZC	SIS-0360RH0ZC	
	Pilar Multi-Unit recto alt. 1,5mm	SIS-0361ZC	SIS-0366C	
	Pilar Multi-Unit recto alt. 2,5mm	SIS-0362ZC	SIS-0367C	
	Pilar Multi-Unit recto alt. 3,5mm	SIS-0363ZC	SIS-0368C	
	Pilar Multi-Unit recto alt. 4,5mm	SIS-0364ZC	SIS-0369C	
	Pilar Multi-Unit recto alt. 5,5mm	SIS-0365ZC	SIS-0370C	
	Pilar Multi-Unit recto alt. 6,5mm	SIS-0360NH6ZC	SIS-0360RH6ZC	
	mini MULTI-UNIT mini Pilar Multi-Unit recto alt. 1,5mm	ARO-0380NH1Z		
	Pilar Multi-Unit recto alt. 2,5mm	ARO-0380NH2Z		
	Pilar Multi-Unit recto alt. 3,5mm	ARO-0380NH3Z		
	Pilar Multi-Unit recto alt. 4,5mm	ARO-0380NH4Z		
	Pilar Multi-Unit recto alt. 5,5mm	ARO-0380NH5Z		
	Pilar Multi-Unit recto alt. 6,5mm	ARO-0380NH6Z		
	Pilar Multi-Unit angul. 17° alt. 2mm	SIS-0371		
	Pilar Multi-Unit angul. 17° alt. 3mm	SIS-0372	SIS-0376	
	Pilar Multi-Unit angul. 17° alt. 4mm	SIS-0373	SIS-0377	
	Pilar Multi-Unit angul. 30° alt. 4mm	SIS-0374	SIS-0378	
	Pilar Multi-Unit angul. 30° alt. 5mm	SIS-0375	SIS-0379	
	H Hexagonal 1,27			
	SMART ANGLE Tornillo Smart Angle	SIS-2007	SIS-2007	SIS-2007
	Tornillo Smart Angle alt. 3mm/4mm	SIS-2007HG	SIS-2007HG	
	CALCINABLE ANGULADA PARA BASES DE Cr-Co Chimenea ang. 17°	SIS-8207A	SIS-8207A	SIS-8207A
	Chimenea ang. 30°	SIS-8207B	SIS-8207B	SIS-8207B

F: 0300



BIOMET 3I® CERTAIN®

Hexágono Interno "Click"

	NP 3.4	RP 4.1	WP 5.0
Coping impresión (cubeta abierta) Hexagonal 1,20	SIS-0420	SIS-0401	SIS-0467
Análogo	SIS-0421	SIS-0402	SIS-0437
Tornillo fijación análogo digital Plana/Cruz	SIS-8888	SIS-8888	SIS-8888
Tapón cicatrización alt. 2mm	SIS-0423	SIS-0404	SIS-0439
Tapón cicatrización alt. 3mm	SIS-0424	SIS-0405	SIS-0440
Tapón cicatrización alt. 4mm	SIS-0425	SIS-0406	SIS-0441
Tapón cicatrización alt. 5mm Hexagonal 1,20/Plana	SIS-0426	SIS-0407	SIS-0442
Pilar recto antirrotatorio	SIS-0428	SIS-0409	SIS-0405WA
Pilar angulado 15°	SIS-0482N		
Pilar angulado 25°	SIS-0483N	SIS-0483R	
Pilar provisional rotatorio	SIS-0450XR	SIS-0450RR	
Pilar provisional antirrotatorio *Tornillos se venden por separado	SIS-0450XA	SIS-0450RA	
SMART Ti-BASE Ti-Base rotatoria	SIS-0408NR	SIS-0408RR	SIS-0408WR
Ti-Base antirrotatoria	SIS-0408NA	SIS-0408RA	SIS-0408WA
Ti-Base HG 2mm rotatoria	SIS-0408NRG2	SIS-0408RRG2	
Ti-Base HG 2mm antirrotatoria	SIS-0408NAG2	SIS-0408RAG2	
Ti-Base HG 3mm rotatoria	SIS-0408NRG3	SIS-0408RRG3	
Ti-Base HG 3mm antirrotatoria	SIS-0408NAG3	SIS-0408RAG3	
Ti-Base HG 4mm rotatoria	SIS-0408NRG4	SIS-0408RRG4	
Ti-Base HG 4mm antirrotatoria	SIS-0408NAG4	SIS-0408RAG4	
Ti-Base HC 7mm rotatoria	SIS-0408NRC7	SIS-0408RRC7	
Ti-Base HC 7mm antirrotatoria	SIS-0408NAC7	SIS-0408RAC7	
Ti-Base HG 2mm HC 7mm rotatoria	SIS-0408NRG2C7	SIS-0408RRG2C7	
Ti-Base HG 2mm HC 7mm antirrotatoria	SIS-0408NAG2C7	SIS-0408RAG2C7	
Ti-Base HG 3mm HC 7mm rotatoria	SIS-0408NRG3C7	SIS-0408RRG3C7	
Ti-Base HG 3mm HC 7mm antirrotatoria	SIS-0408NAG3C7	SIS-0408RAG3C7	
Ti-Base HG 4mm HC 7mm rotatoria	SIS-0408NRG4C7	SIS-0408RRG4C7	
Ti-Base HG 4mm HC 7mm antirrotatoria	SIS-0408NAG4C7	SIS-0408RAG4C7	
Ti-Base HC 9mm rotatoria (recortable)	SIS-0408NRC9	SIS-0408RRC9	SIS-0408WRC9
Ti-Base HC 9mm antirrotatoria (recortable) *Tornillos se venden por separado	SIS-0408NAC9	SIS-0408RAC9	SIS-0408WAC9
Scanbody (Ti) *Tornillos se venden por separado	SIS-0490N	SIS-0490R	SIS-0490W
Calcinable rotatorio	SIS-0429	SIS-0410	SIS-0445
Calcinable antirrotatorio	SIS-0430	SIS-0411	SIS-0446
Sobrecolable Cr-Co rotatorio	SIS-0433	SIS-0414	SIS-0449
Sobrecolable Cr-Co antirrotatorio *Tornillos se venden por separado	SIS-0434	SIS-0415	SIS-0450



BIOMET 3I® CERTAIN®

Hexágono Interno "Click"



Pilar SISCator alt. 1mm

SIS-0417N

SIS-0417

SIS-0417

Pilar SISCator alt. 2mm

SIS-0418N

SIS-0418

SIS-0418

Pilar SISCator alt. 3mm

SIS-0419N

SIS-0419

SIS-0419

Pilar SISCator alt. 4mm

SIS-0453N

SIS-0453

SIS-0453

Pilar SISCator alt. 5mm

SIS-0454N

SIS-0454

SIS-0454

Pilar SISCator alt. 6mm

SIS-0456N

SIS-0456

SIS-0456



Pilar SISCator angulado 15° alt. 1,5mm.

SIS-0417H1N

SIS-0417H1R

Pilar SISCator angulado 15° alt. 3mm.

SIS-0417H3N

SIS-0417H3R



Tornillo rotatorio M1,6 (hex. 1,20)

SIS-0452

SIS-0455

SIS-0455

Tornillo antirrotatorio M1,6 (hex. 1,20)

SIS-0452

SIS-0452

SIS-0452



B TORNILLOS CON RECUBRIMIENTO BIOCARB

Tornillo rotatorio M1,6 (hex. 1,20)

SIS-0452B

SIS-0455B

SIS-0455B

Tornillo antirrotatorio M1,6 (hex. 1,20)

SIS-0452B

SIS-0452B

SIS-0452B

SIS MULTI-UNIT SIS



Pilar Multi-Unit recto alt. 1mm.

SIS-0460NH0C

SIS-0460RH0C

SIS-0460WH0C

Pilar Multi-Unit recto alt. 1,5mm

SIS-0457NC

SIS-0457C

SIS-0457WC

Pilar Multi-Unit recto alt. 2,5mm

SIS-0458NC

SIS-0458C

SIS-0458WC

Pilar Multi-Unit recto alt. 3,5mm

SIS-0459NC

SIS-0459C

SIS-0459WC

Pilar Multi-Unit recto alt. 4,5mm

SIS-0460NC

SIS-0460C

SIS-0460WC

Pilar Multi-Unit recto alt. 5,5mm

SIS-0460NH5C

SIS-0460RH5C

Pilar Multi-Unit recto alt. 6,5mm

SIS-0460NH6C

SIS-0460RH6C

mini MULTI-UNIT mini



Pilar Multi-Unit recto alt. 1,5mm

ARO-0480NH1

Pilar Multi-Unit recto alt. 2,5mm

ARO-0480NH2

Pilar Multi-Unit recto alt. 3,5mm

ARO-0480NH3

Pilar Multi-Unit recto alt. 4,5mm

ARO-0480NH4

Pilar Multi-Unit recto alt. 5,5mm

ARO-0480NH5

Pilar Multi-Unit recto alt. 6,5mm

ARO-0480NH6



Pilar Multi-Unit angul. 17° alt. 2mm

SIS-0462N

SIS-0462

SIS-0462W

Pilar Multi-Unit angul. 17° alt. 4mm

SIS-0464N

SIS-0464

SIS-0464W

Pilar Multi-Unit angul. 30° alt. 3mm

SIS-0465N

SIS-0465

SIS-0465W

Pilar Multi-Unit angul. 30° alt. 5mm

SIS-0466N

SIS-0466

SIS-0466W

Hexagonal 1,20



SMART ANGLE

Tornillo Smart Angle

SIS-2006

SIS-2006

SIS-2006

Tornillo Smart Angle alt. 3mm/4mm

SIS-2006HG

SIS-2006HG



CALCINABLE ANGULADA PARA BASES DE Cr-Co

Chimenea ang. 17°

SIS-8207A

SIS-8207A

SIS-8207A

Chimenea ang. 30°

SIS-8207B

SIS-8207B

SIS-8207B



ASTRA®TECH OSSEOSPEED®

Cónica Interna

Yellow 3.0

Aqua 3.5/4.0

Lilac 4.5/5.0



Coping impresión (cubeta abierta)

Hexagonal 1,27

SIS-0501X

SIS-0501

SIS-0519



Análogo

Tornillo fijación análogo digital

Plana/Cruz

SIS-0502X

SIS-0502

SIS-0520

SIS-8888

SIS-8888

SIS-8888



Tapón cicatrización alt. 2mm

Tapón cicatrización alt. 4mm

Tapón cicatrización alt. 6mm

Tapón cicatrización alt. 8mm

Hexagonal 1,27

SIS-0504XH2

SIS-0504

SIS-0522

SIS-0504XH4

SIS-0505

SIS-0523

SIS-0504XH6

SIS-0506

SIS-0524

SIS-0507

SIS-0525



Pilar recto rotatorio

Pilar recto antirrotatorio

Pilar angulado 15°

Pilar angulado 25°

Pilar provisional rotatorio

Pilar provisional antirrotatorio

SIS-0505XA

SIS-0571N

SIS-0571R

SIS-0508

SIS-0526

SIS-0582N

SIS-0582R

SIS-0583N

SIS-0583R

SIS-0572N

SIS-0572R

SIS-0573N

SIS-0573R

*Tornillos se venden por separado

SMART
TI-BASE



Ti-Base rotatoria

Ti-Base antirrotatoria

SIS-0508XR

SIS-0508NR

SIS-0508RR

SIS-0508XA

SIS-0508NA

SIS-0508RA



Ti-Base HG 2,5mm rotatoria

Ti-Base HG 2,5mm antirrotatoria

Ti-Base HG 3,5mm rotatoria

Ti-Base HG 3,5mm antirrotatoria

Ti-Base HG 4,5mm rotatoria

Ti-Base HG 4,5mm antirrotatoria

SIS-0508XRG2

SIS-0508NRG2

SIS-0508RRG2

SIS-0508XAG2

SIS-0508NAG2

SIS-0508RAG2

SIS-0508XRG3

SIS-0508NRG3

SIS-0508RRG3

SIS-0508XAG3

SIS-0508NAG3

SIS-0508RAG3

SIS-0508XRG4

SIS-0508NRG4

SIS-0508RRG4

SIS-0508XAG4

SIS-0508NAG4

SIS-0508RAG4



Ti-Base HC 7mm rotatoria

Ti-Base HC 7mm antirrotatoria

SIS-0508XRC7

SIS-0508NRC7

SIS-0508RRC7

SIS-0508XAC7

SIS-0508NAC7

SIS-0508RAC7



Ti-Base HG 2,5mm HC 7mm rotatoria

Ti-Base HG 2,5mm HC 7mm antirrotatoria

Ti-Base HG 3,5mm HC 7mm rotatoria

Ti-Base HG 3,5mm HC 7mm antirrotatoria

Ti-Base HG 4,5mm HC 7mm rotatoria

Ti-Base HG 4,5mm HC 7mm antirrotatoria

SIS-0508XRG2C7

SIS-0508NRG2C7

SIS-0508RRG2C7

SIS-0508XAG2C7

SIS-0508NAG2C7

SIS-0508RAG2C7

SIS-0508XRG3C7

SIS-0508NRG3C7

SIS-0508RRG3C7

SIS-0508XAG3C7

SIS-0508NAG3C7

SIS-0508RAG3C7

SIS-0508XRG4C7

SIS-0508NRG4C7

SIS-0508RRG4C7

SIS-0508XAG4C7

SIS-0508NAG4C7

SIS-0508RAG4C7



Ti-Base HC 9mm rotatoria (recortable)

Ti-Base HC 9mm antirrotatoria (recortable)

SIS-0508XRC9

SIS-0508NRC9

SIS-0508RRC9

SIS-0508XAC9

SIS-0508NAC9

SIS-0508RAC9

*Tornillos se venden por separado



Scanbody (Ti)

SIS-0590X

SIS-0590R

SIS-0590W

*Tornillos se venden por separado



Calcinable rotatorio

Calcinable antirrotatorio

Sobrecolable Cr-Co rotatorio

Sobrecolable Cr-Co antirrotatorio

SIS-0530XR

SIS-0517R

SIS-0535R

SIS-0530XA

SIS-0517

SIS-0535

SIS-0515R

SIS-0533R

SIS-0515

SIS-0533

*Tornillos se venden por separado



ASTRA®TECH OSSEOSPEED®

Cónica Interna

	Yellow 3.0	Aqua 3.5/4.0	Lilac 4.5/5.0	
	Pilar SISCator alt. 1mm	SIS-0510XH1	SIS-0544	SIS-0537
	Pilar SISCator alt. 2mm	SIS-0510XH2	SIS-0545	SIS-0538
	Pilar SISCator alt. 3mm	SIS-0510XH3	SIS-0546	SIS-0539
	Pilar SISCator alt. 4mm	SIS-0510XH4	SIS-0547	SIS-0548
	Pilar SISCator alt. 5mm	SIS-0510XH5	SIS-0549	SIS-0550
	Pilar SISCator alt. 6mm	SIS-0510XH6	SIS-0552	SIS-0553
	Pilar SISCator angulado 15° alt. 1,5mm.		SIS-0517H1N	SIS-0517H1R
	Pilar SISCator angulado 15° alt. 3mm.		SIS-0517H3N	SIS-0517H3R
	Tornillo M1,4 (hex. 1,27)	SIS-0514X	SIS-0540	SIS-0541
	Tornillo M1,6 (hex. 1,27)			
	Tornillo M2,0 (hex. 1,27)			
	TORNILLOS CON RECUBRIMIENTO BIOCARB			
	Tornillo M1,4 (hex. 1,27)	SIS-0514XB		
	Tornillo M1,6 (hex. 1,27)		SIS-0540B	
	Tornillo M2,0 (hex. 1,27)			SIS-0541B
	SIS MULTI-UNIT SIS			
	Pilar Multi-Unit recto alt. 1,5mm	SIS-0560XH1C	SIS-0554C	SIS-0558C
	Pilar Multi-Unit recto alt. 2,5mm	SIS-0560XH2C	SIS-0555C	SIS-0559C
	Pilar Multi-Unit recto alt. 3,5mm	SIS-0560XH3C	SIS-0556C	SIS-0560C
	Pilar Multi-Unit recto alt. 4,5mm	SIS-0560XH4C	SIS-0557C	SIS-0561C
	Pilar Multi-Unit recto alt. 5,5mm		SIS-0560NH5C	SIS-0560RH5C
	Pilar Multi-Unit recto alt. 6,5mm		SIS-0560NH6C	SIS-0560RH6C
	mini MULTI-UNIT mini			
	Pilar Multi-Unit recto alt. 1,5mm	ARO-0580XH1	ARO-0580NH1	
	Pilar Multi-Unit recto alt. 2,5mm	ARO-0580XH2	ARO-0580NH2	
	Pilar Multi-Unit recto alt. 3,5mm	ARO-0580XH3	ARO-0580NH3	
	Pilar Multi-Unit recto alt. 4,5mm	ARO-0580XH4	ARO-0580NH4	
	Pilar Multi-Unit recto alt. 5,5mm		ARO-0580NH5	
	Pilar Multi-Unit recto alt. 6,5mm		ARO-0580NH6	
	Pilar Multi-Unit angul. 17° alt. 2,5mm		SIS-0562	SIS-0564
	Pilar Multi-Unit angul. 17° alt. 3,5mm		SIS-0563	SIS-0565
	Pilar Multi-Unit angul. 30° alt. 3,5mm		SIS-0566	SIS-0568
Pilar Multi-Unit angul. 30° alt. 4,5mm		SIS-0567	SIS-0569	
	Hexagonal 1,27			
	SMART ANGLE			
	Tornillo Smart Angle	SIS-0515X	SIS-2018	SIS-2019
	Tornillo Smart Angle alt. 3mm/4mm	SIS-0515XHG	SIS-2018HG	SIS-2019HG
	CALCINABLE ANGULADA PARA BASES DE Cr-Co			
	Chimenea ang. 17°	SIS-8216A	SIS-8207A	SIS-8207A
Chimenea ang. 30°	SIS-8216B	SIS-8207B	SIS-8207B	

F: 0500



STRAUMANN® TISSUE LEVEL®

Octógono



Coping impresión (cubeta abierta)
Coping impresión pilar synOcta (cubeta abierta)
• Torx

RN 4.8

SIS-0601
SIS-0601RS

WN 6.5

SIS-0601W



Análogo
Análogo synOcta
Tornillo fijación análogo digital
• Plana/Cruz

SIS-0602
SIS-0637
SIS-8888

SIS-0630
SIS-8888



Tapón cicatrización alt. 1,5mm
Tapón cicatrización alt. 3mm
Tapón cicatrización alt. 4,5mm
• Torx

SIS-0604
SIS-0605
SIS-0606



Pilar recto antirrotatorio directo
Pilar recto antirrotatorio synOcta
Pilar angulado 25°
Pilar synOcta

SIS-0605RA
SIS-0605RSA
SIS-0683R
SIS-0612

SIS-0605WA



Pilar Octa
Pilar provisional synOcta rotatorio
Pilar provisional rotatorio
Pilar provisional antirrotatorio

SIS-0613
SIS-0629
SIS-0641
SIS-0642

**Tornillos se venden por separado*



Ti-Base rotatoria
Ti-Base antirrotatoria

SIS-0608RR
SIS-0608RA

SIS-0608WR
SIS-0608WA



Ti-Base HG 2mm rotatoria
Ti-Base HG 2mm antirrotatoria
Ti-Base HG 3mm rotatoria
Ti-Base HG 3mm antirrotatoria
Ti-Base HG 4mm rotatoria
Ti-Base HG 4mm antirrotatoria

SIS-0608RRG2
SIS-0608RAG2
SIS-0608RRG3
SIS-0608RAG3
SIS-0608RRG4
SIS-0608RAG4



Ti-Base HC 7mm rotatoria
Ti-Base HC 7mm antirrotatoria

SIS-0608RRC7
SIS-0608RAC7



Ti-Base HG 2mm HC 7mm rotatoria
Ti-Base HG 2mm HC 7mm antirrotatoria
Ti-Base HG 3mm HC 7mm rotatoria
Ti-Base HG 3mm HC 7mm antirrotatoria
Ti-Base HG 4mm HC 7mm rotatoria
Ti-Base HG 4mm HC 7mm antirrotatoria

SIS-0608RRG2C7
SIS-0608RAG2C7
SIS-0608RRG3C7
SIS-0608RAG3C7
SIS-0608RRG4C7
SIS-0608RAG4C7



Ti-Base HC 9mm rotatoria (recortable)
Ti-Base HC 9mm antirrotatoria (recortable)

SIS-0608RRC9
SIS-0608RAC9

SIS-0608WRC9
SIS-0608WAC9



Ti-Base synOcta rotatoria
Ti-Base synOcta antirrotatoria

SIS-0612RSR
SIS-0612RSA

**Tornillos se venden por separado*



Scanbody Octógono (Ti)
Scanbody synOcta (Ti)

SIS-0690RN
SIS-0690RS

SIS-0690WN

**Tornillos se venden por separado*



STRAUMANN® TISSUE LEVEL®

Octógono

		RN 4.8	WN 6.5
	Calcinable directo rotatorio	SIS-0614	SIS-0631
	Calcinable directo antirrotatorio	SIS-0615	SIS-0632
	Sobrecolable Cr-Co rotatorio	SIS-0618	SIS-0630WR
	Sobrecolable Cr-Co antirrotatorio	SIS-0619	SIS-0630WA
	Calcinable synOcta rotatorio	SIS-0616	
	Calcinable synOcta antirrotatorio	SIS-0617	
	Sobrecolable Cr-Co synOcta rotatorio	SIS-0634	
	Sobrecolable Cr-Co synOcta antirrotatorio	SIS-0635	
	Pilar SIScator alt. 1mm	SIS-0621	
	Pilar SIScator alt. 2mm	SIS-0622	
	Pilar SIScator alt. 3mm	SIS-0623	
	Pilar SIScator alt. 4mm	SIS-0626	
	Pilar SIScator alt. 5mm	SIS-0627	
	Pilar SIScator alt. 6mm	SIS-0628	
	Pilar SIScator angulado 15° alt.1mm.	SIS-0617H1R	
	Pilar SIScator angulado 15° alt. 2mm.	SIS-0617H2R	
	Tornillo directo a implante M2 (Torx)	SIS-0625	SIS-0625
	Tornillo synOcta (Torx)	SIS-0624	SIS-0624
	B TORNILLOS CON RECUBRIMIENTO BIOCARB		
	Tornillo directo a implante M2 (Torx)	SIS-0625B	SIS-0625B
	Tornillo synOcta (Torx)	SIS-0624B	SIS-0624B
	SIS MULTI-UNIT SIS		
	Pilar Multi-Unit recto alt. 0,9mm	SIS-0640C	
	Pilar Multi-Unit angul. 17° alt. 2,5mm	SIS-0670RH2	
	Pilar Multi-Unit angul. 30° alt. 3,5mm	SIS-0671RH3	
	T Torx		
	SMART ANGLE		
	Tornillo Smart Angle	SIS-2008	SIS-2008
	Tornillo Smart Angle alt. 3mm/4mm	SIS-2008HG	
	Tornillo synOcta Smart Angle	SIS-2010	
	CALCINABLE ANGULADA PARA BASES DE Cr-Co		
	Chimenea ang. 17°	SIS-8207A	SIS-8207A
	Chimenea ang. 30°	SIS-8207B	SIS-8207B

F: 0600



BTI® INTERNA

Tetralobular Interno

RP 4.1

WP 5.5



Coping impresión (cubeta abierta)

SIS-0721

SIS-0736



Análogo
Tornillo fijación análogo digital
Plana/Cruz

SIS-0701

SIS-0725

SIS-8888

SIS-8888



Tapón cicatrización alt. 2mm
Tapón cicatrización alt. 3mm
Tapón cicatrización alt. 4mm
Tapón cicatrización alt. 5mm
Hexagonal 1,20

SIS-0717

SIS-0718

SIS-0719

SIS-0720



Pilar recto antirrotatorio
Pilar provisional rotatorio
Pilar provisional antirrotatorio

SIS-0703

SIS-0723

SIS-0724

SIS-0705WA

SIS-0723W

SIS-0724W

*Tornillos se venden por separado

SMART
TI-BASE



Ti-Base rotatoria
Ti-Base antirrotatoria

SIS-0708RR

SIS-0708RA

SIS-0708WR

SIS-0708WA



Ti-Base HG 2mm rotatoria
Ti-Base HG 2mm antirrotatoria Ti-Base HG 3mm rotatoria
Ti-Base HG 3mm antirrotatoria Ti-Base HG 4mm rotatoria
Ti-Base HG 4mm antirrotatoria

SIS-0708RRG2

SIS-0708RAG2

SIS-0708RRG3

SIS-0708RAG3

SIS-0708RRG4

SIS-0708RAG4



Ti-Base HC 7mm rotatoria
Ti-Base HC 7mm antirrotatoria

SIS-0708RRC7

SIS-0708RAC7



Ti-Base HG 2mm HC 7mm rotatoria
Ti-Base HG 2mm HC 7mm antirrotatoria
Ti-Base HG 3mm HC 7mm rotatoria
Ti-Base HG 3mm HC 7mm antirrotatoria
Ti-Base HG 4mm HC 7mm rotatoria
Ti-Base HG 4mm HC 7mm antirrotatoria

SIS-0708RRG2C7

SIS-0708RAG2C7

SIS-0708RRG3C7

SIS-0708RAG3C7

SIS-0708RRG4C7

SIS-0708RAG4C7



Ti-Base HC 9mm rotatoria (recortable)
Ti-Base HC 9mm antirrotatoria (recortable)
*Tornillos se venden por separado

SIS-0708RRC9

SIS-0708RAC9

SIS-0708WRC9

SIS-0708WAC9



Scanbody (Ti)

SIS-0790R

SIS-0790W

*Tornillos se venden por separado



Calcinable rotatorio
Calcinable antirrotatorio
Sobrecolable Cr-Co rotatorio
Sobrecolable Cr-Co antirrotatorio
*Tornillos se venden por separado

SIS-0704

SIS-0705

SIS-0708

SIS-0709

SIS-0726

SIS-0727

SIS-0728

SIS-0729

*Tornillos se venden por separado



BTI® INTERNA

Tetralobular Interno

	RP 4.1	WP 5.5	
	Pilar SIScator alt. 1mm	SIS-0712	SIS-0712
	Pilar SIScator alt. 2mm	SIS-0713	SIS-0713
	Pilar SIScator alt. 3mm	SIS-0714	SIS-0714
	Pilar SIScator alt. 4mm	SIS-0715	SIS-0715
	Pilar SIScator alt. 5mm	SIS-0716	SIS-0716
	Pilar SIScator alt. 6mm	SIS-0722	SIS-0722
	Pilar SIScator angulado 15° alt. 1,5mm.	SIS-0717H1R	
	Pilar SIScator angulado 15° alt. 3mm.	SIS-0717H3R	
	Tornillo M1,8 (hex. 1,20)	SIS-0710	SIS-0710
	Tornillo M1,8 (cuadrado 1,30)	SIS-0710Q	SIS-0710Q
	Tornillo M1,8 (hex. 1,20)	SIS-0710B	SIS-0710B
	Tornillo M1,8 (cuadrado 1,30)	SIS-0710QB	SIS-0710QB
	Pilar Multi-Unit recto alt. 1mm	SIS-0760RH0	SIS-0760WH0
	Pilar Multi-Unit recto alt. 1,5mm	SIS-0738RC	SIS-0739WC
	Pilar Multi-Unit recto alt. 2,5mm	SIS-0739RC	SIS-0740WC
	Pilar Multi-Unit recto alt. 3,5mm	SIS-0740RC	SIS-0741WC
	Pilar Multi-Unit recto alt. 4,5mm	SIS-0741RC	
	Pilar Multi-Unit recto alt. 5,5mm	SIS-0742RC	
	Pilar Multi-Unit recto alt. 6,5mm	SIS-0760RH6C	
	Pilar Multi-Unit angul. 17° alt. 2mm	SIS-0770RH2	SIS-0770RH2
	Pilar Multi-Unit angul. 17° alt. 3mm	SIS-0770RH3	SIS-0770RH3
	Pilar Multi-Unit angul. 17° alt. 4mm	SIS-0770RH4	SIS-0770RH4
	Pilar Multi-Unit angul. 30° alt. 3mm	SIS-0771RH3	SIS-0771RH3
	Pilar Multi-Unit angul. 30° alt. 4mm	SIS-0771RH4	SIS-0771RH4
	Pilar Multi-Unit angul. 30° alt. 5mm	SIS-0771RH5	SIS-0771RH5
	Tornillo Smart Angle	SIS-2023	SIS-2023
	Tornillo Smart Angle alt. 3mm/4mm	SIS-2023HG	
	Chimenea ang. 17°	SIS-8207A	SIS-8207A
	Chimenea ang. 30°	SIS-8207B	SIS-8207B

F: 0700

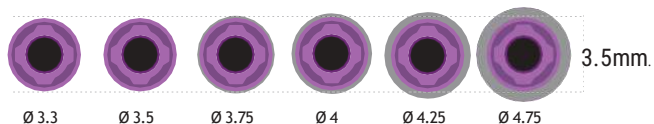









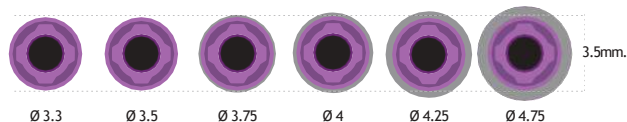

	Coping impresión (cubeta abierta)	SIS-0721N
	Análogo	SIS-0701N
	Tornillo fijación análogo digital	SIS-8888
	Plana/Cruz	
	Tapón cicatrización alt. 2mm	SIS-0717N
	Tapón cicatrización alt. 3mm	SIS-0718N
	Tapón cicatrización alt. 4mm	SIS-0719N
	Tapón cicatrización alt. 5mm	SIS-0720N
	Hexagonal 1,20	
	Pilar recto antirrotatorio	SIS-0703N
	Pilar provisional rotatorio	SIS-0723N
	Pilar provisional antirrotatorio	SIS-0724N
	<i>*Tornillos se venden por separado</i>	
	Ti-Base rotatoria	SIS-0708NR
	Ti-Base antirrotatoria	SIS-0708NA
	Ti-Base HG 2mm rotatoria	SIS-0708NRG2
	Ti-Base HG 2mm antirrotatoria	SIS-0708NAG2
	Ti-Base HG 3mm rotatoria	SIS-0708NRG3
	Ti-Base HG 3mm antirrotatoria	SIS-0708NAG3
	Ti-Base HG 4mm rotatoria	SIS-0708NRG4
	Ti-Base HG 4mm antirrotatoria	SIS-0708NAG4
	Ti-Base HC 7mm rotatoria	SIS-0708NRC7
	Ti-Base HC 7mm antirrotatoria	SIS-0708NAC7
	Ti-Base HG 2mm HC 7mm rotatoria	SIS-0708NRG2C7
	Ti-Base HG 2mm HC 7mm antirrotatoria	SIS-0708NAG2C7
	Ti-Base HG 3mm HC 7mm rotatoria	SIS-0708NRG3C7
	Ti-Base HG 3mm HC 7mm antirrotatoria	SIS-0708NAG3C7
	Ti-Base HG 4mm HC 7mm rotatoria	SIS-0708NRG4C7
	Ti-Base HG 4mm HC 7mm antirrotatoria	SIS-0708NAG4C7
	Ti-Base HC 9mm rotatoria (recortable)	SIS-0708NRC9
	Ti-Base HC 9mm antirrotatoria (recortable)	SIS-0708NAC9
	<i>*Tornillos se venden por separado</i>	
	Scanbody (Ti)	SIS-0790N
	<i>*Tornillos se venden por separado</i>	
	Sobrecolable Cr-Co rotatorio	SIS-0730NR
	Sobrecolable Cr-Co antirrotatorio	SIS-0730NA
	<i>*Tornillos se venden por separado</i>	

(*ADITAMENTOS SOLO BAJO PEDIDO)



BTI® CORE
Tetralobular Interno



	Pilar SIScator alt. 1mm	SIS-0712N
	Pilar SIScator alt. 2mm	SIS-0713N
	Pilar SIScator alt. 3mm	SIS-0714N
	Pilar SIScator alt. 4mm	SIS-0715N
	Pilar SIScator alt. 5mm	SIS-0716N
	Pilar SIScator alt. 6mm	SIS-0722N
	Pilar SIScator angulado 15° alt. 1,5mm.	SIS-0717H1N
	Pilar SIScator angulado 15° alt. 3mm.	SIS-0717H3N
	Tornillo M1,8 (hex. 1,20)	SIS-0710N
	B TORNILLOS CON RECUBRIMIENTO BIOCARB Tornillo M1,8 (hex. 1,20)	SIS-0710NB
	SIS MULTI-UNIT SIS Pilar Multi-Unit recto alt. 1mm	SIS-0760NH0
	Pilar Multi-Unit recto alt. 1,5mm	SIS-0738NC
	Pilar Multi-Unit recto alt. 2,5mm	SIS-0739NC
	Pilar Multi-Unit recto alt. 3,5mm	SIS-0740NC
	Pilar Multi-Unit recto alt. 4,5mm	SIS-0741NC
	Pilar Multi-Unit recto alt. 5,5mm	SIS-0742NC
	mini MULTI-UNIT mini Pilar Multi-Unit recto alt. 1,5mm	ARO-0780NH1
	Pilar Multi-Unit recto alt. 2,5mm	ARO-0780NH2
	Pilar Multi-Unit recto alt. 3,5mm	ARO-0780NH3
	Pilar Multi-Unit recto alt. 4,5mm	ARO-0780NH4
	Pilar Multi-Unit recto alt. 5,5mm	ARO-0780NH5
	Pilar Multi-Unit angul. 17° alt. 2mm	SIS-0770NH2
	Pilar Multi-Unit angul. 17° alt. 3mm	SIS-0770NH3
	Pilar Multi-Unit angul. 30° alt. 3mm	SIS-0771NH3
	Pilar Multi-Unit angul. 30° alt. 4mm	SIS-0771NH4
	Unigrip	
	SMART ANGLE Tornillo Smart Angle	SIS-2023
	Tornillo Smart Angle alt. 3mm/4mm	SIS-2023HG
	17° 30° CALCINABLE ANGULADA PARA BASES DE Cr-Co Chimenea ang. 17°	SIS-8207A
	Chimenea ang. 30°	SIS-8207B

F: 0700



NOBEL BIOCARE® REPLACE SELECT®

Trilobular



Coping impresión (cubeta abierta)

Unigrip

NP 3.5

SIS-0801N

RP 4.3

SIS-0801

WP 5.0

SIS-0801W



Análogo

Tornillo fijación análogo digital

Plana/Cruz

SIS-0821

SIS-8888

SIS-0802

SIS-8888

SIS-0837

SIS-8888



Tapón cicatrización alt. 2mm

Tapón cicatrización alt. 3mm

Tapón cicatrización alt. 4mm

Tapón cicatrización alt. 5mm

Unigrip/Plana

SIS-0823

SIS-0824

SIS-0825

SIS-0826

SIS-0804

SIS-0805

SIS-0806

SIS-0807

SIS-0839

SIS-0840

SIS-0841

SIS-0842



Pilar recto antirrotatorio alt. 1mm

Pilar recto antirrotatorio alt. 2mm

Pilar provisional rotatorio

Pilar provisional antirrotatorio

Pilar provisional rotatorio (PEEK)

**Tornillos se venden por separado*

SIS-0828

SIS-0856

SIS-0857

SIS-0809

SIS-0808

SIS-0858

SIS-0859

SIS-0880

SIS-0844

SIS-0860

SIS-0861

SMART
TI-BASE



Ti-Base rotatoria

Ti-Base antirrotatoria

SIS-0808NR

SIS-0808NA

SIS-0808RR

SIS-0808RA

SIS-0808WR

SIS-0808WA



Ti-Base HC 9mm rotatoria (recortable)

Ti-Base HC 9mm antirrotatoria (recortable)

**Tornillos se venden por separado*

SIS-0808NRC9

SIS-0808NAC9

SIS-0808RRC9

SIS-0808RAC9

SIS-0808WRC9

SIS-0808WAC9



Scanbody (Ti)

**Tornillos se venden por separado*

SIS-0890N

SIS-0890R

SIS-0890W



Calcinable rotatorio

Calcinable antirrotatorio

Sobrecolable Cr-Co rotatorio

Sobrecolable Cr-Co antirrotatorio

**Tornillos se venden por separado*

SIS-0829

SIS-0830

SIS-0833

SIS-0834

SIS-0810

SIS-0811

SIS-0814

SIS-0815

SIS-0845

SIS-0846

SIS-0849

SIS-0850



Pilar SIScator alt. 0mm

Pilar SIScator alt. 1mm

Pilar SIScator alt. 2mm

Pilar SIScator alt. 3mm

Pilar SIScator alt. 4mm

Pilar SIScator alt. 5mm

Pilar SIScator alt. 6mm

SIS-0879N

SIS-0817N

SIS-0818N

SIS-0819N

SIS-0854N

SIS-0855N

SIS-0862N

SIS-0879R

SIS-0817

SIS-0818

SIS-0819

SIS-0854

SIS-0855

SIS-0862

SIS-0817W

SIS-0818W

SIS-0819W

SIS-0854W

SIS-0855W



NOBEL BIOCARE® REPLACE SELECT®

Trilobular

		NP 3.5	RP 4.3	WP 5.0
	Tornillo M1,8 (unigrip)	SIS-0852		
	Tornillo M2 (unigrip)		SIS-0853	SIS-0853
	TORNILLOS RECUBRIMIENTO BIOCARB			
	Tornillo M1,8 (unigrip)	SIS-0852B		
	Tornillo M2 (unigrip)		SIS-0853B	SIS-0853B
	SIS MULTI-UNIT SIS			
	Pilar Multi-Unit recto alt. 1mm	SIS-0860NH0C	SIS-0860RH0C	SIS-0860WH0C
	Pilar Multi-Unit recto alt. 1,5mm	SIS-0863C	SIS-0866C	SIS-0871C
	Pilar Multi-Unit recto alt. 2,5mm	SIS-0864C	SIS-0867C	SIS-0872C
	Pilar Multi-Unit recto alt. 3,5mm	SIS-0865C	SIS-0868C	SIS-0873C
	Pilar Multi-Unit recto alt. 4,5mm		SIS-0869C	
	Pilar Multi-Unit recto alt. 5,5mm		SIS-0870C	
	Pilar Multi-Unit angul. 17° alt. 2mm	SIS-0870NH2	SIS-0874	
	Pilar Multi-Unit angul. 17° alt. 3mm	SIS-0870NH3	SIS-0875	
	Pilar Multi-Unit angul. 17° alt. 4mm		SIS-0876	
	Pilar Multi-Unit angul. 30° alt. 4mm		SIS-0877	
	Pilar Multi-Unit angul. 30° alt. 5mm		SIS-0878	
	Unigrip			
	SMART ANGLE			
	Tornillo Smart Angle	SIS-2005	SIS-2004	SIS-2004
	CALCINABLE ANGULADA PARA BASES DE Cr-Co			
	Chimenea ang. 17°	SIS-8207A	SIS-8207A	SIS-8207A
	Chimenea ang. 30°	SIS-8207B	SIS-8207B	SIS-8207B

F: 0800



NOBEL BIOCARE® NOBELACTIVE®

Interna Activa

NP 3.5/3.75

RP 4.3/5.0



Coping impresión (cubeta abierta)

Unigrip

SIS-0948

SIS-0949



Análogo

Tornillo fijación análogo digital

Plana/Cruz

SIS-0908

SIS-0903

SIS-8888

SIS-8888



Tapón cicatrización alt. 3mm

Tapón cicatrización alt. 5mm

Tapón cicatrización alt. 7mm

Unigrip

SIS-0956

SIS-0901

SIS-0957

SIS-0902

SIS-0958

SIS-0955



Pilar recto antirrotatorio

Pilar angulado 15°

Pilar angulado 25°

Pilar provisional rotatorio

Pilar provisional antirrotatorio

*Tornillos se venden por separado

SIS-0959

SIS-0928

SIS-0982N

SIS-0982R

SIS-0983N

SIS-0983R

SIS-0931

SIS-0929

SIS-0932

SIS-0930



Ti-Base rotatoria



Ti-Base antirrotatoria



Ti-Base HG 2,5mm rotatoria



Ti-Base HG 2,5mm antirrotatoria



Ti-Base HG 3,5mm rotatoria



Ti-Base HG 3,5mm antirrotatoria



Ti-Base HG 4,5mm rotatoria



Ti-Base HG 4,5mm antirrotatoria



Ti-Base HC 7mm rotatoria



Ti-Base HC 7mm antirrotatoria



Ti-Base HG 2,5mm HC 7mm rotatoria



Ti-Base HG 2,5mm HC 7mm antirrotatoria



Ti-Base HG 3,5mm HC 7mm rotatoria

Ti-Base HG 3,5mm HC 7mm antirrotatoria

Ti-Base HG 4,5mm HC 7mm rotatoria

Ti-Base HG 4,5mm HC 7mm antirrotatoria

Ti-Base HC 9mm rotatoria (recortable)

Ti-Base HC 9mm antirrotatoria (recortable)

*Tornillos se venden por separado

SIS-0908NRC7

SIS-0908RRC7

SIS-0908NAC7

SIS-0908RAC7

SIS-0908NRG2C7

SIS-0908RRG2C7

SIS-0908NAG2C7

SIS-0908RAG2C7

SIS-0908NRG3C7

SIS-0908RRG3C7

SIS-0908NAG3C7

SIS-0908RAG3C7

SIS-0908NRG4C7

SIS-0908RRG4C7

SIS-0908NAG4C7

SIS-0908RAG4C7

SIS-0908NRC9

SIS-0908RRC9

SIS-0908NAC9

SIS-0908RAC9



Scanbody (Ti)

*Tornillos se venden por separado

SIS-0990N

SIS-0990R



Calcinable rotatorio

Calcinable antirrotatorio

Sobrecalable Cr-Co rotatorio

Sobrecalable Cr-Co antirrotatorio

*Tornillos se venden por separado

SIS-0910

SIS-0904

SIS-0911

SIS-0905

SIS-0912

SIS-0906

SIS-0913

SIS-0907



NOBEL BIOACTIVE® NOBELACTIVE®

Interna Activa

		NP 3.5/3.75	RP 4.3/5.0
	Pilar SIScator alt. 1mm	SIS-0922	SIS-0916
	Pilar SIScator alt. 2mm	SIS-0923	SIS-0917
	Pilar SIScator alt. 3mm	SIS-0924	SIS-0918
	Pilar SIScator alt. 4mm	SIS-0925	SIS-0919
	Pilar SIScator alt. 5mm	SIS-0926	SIS-0920
	Pilar SIScator alt. 6mm	SIS-0927	SIS-0921
	Pilar SIScator angulado 15° alt. 1,5mm.	SIS-0917H1N	SIS-0917H1R
	Pilar SIScator angulado 15° alt. 3mm.	SIS-0917H3N	SIS-0917H3R
	Tornillo M1,6 (unigrip)	SIS-0915	
	Tornillo M2 (unigrip)		SIS-0914
	B TORNILLOS RECUBRIMIENTO BIOCARB		
	Tornillo M1,6 (unigrip)	SIS-0915B	
	Tornillo M2 (unigrip)		SIS-0914B
	SIS MULTI-UNIT SIS		
	Pilar Multi-Unit recto alt. 1,5mm	SIS-0933C	SIS-0936C
	Pilar Multi-Unit recto alt. 2,5mm	SIS-0934C	SIS-0937C
	Pilar Multi-Unit recto alt. 3,5mm	SIS-0935C	SIS-0938C
	Pilar Multi-Unit recto alt. 4,5mm	SIS-0960C	SIS-0939C
	Pilar Multi-Unit recto alt. 5,5mm	SIS-0961C	SIS-0963C
Pilar Multi-Unit recto alt. 6,5mm	SIS-0962C	SIS-0964C	
	mini MULTI-UNIT mini		
	Pilar Multi-Unit recto alt. 1,5mm	ARO-0980NH1	
	Pilar Multi-Unit recto alt. 2,5mm	ARO-0980NH2	
	Pilar Multi-Unit recto alt. 3,5mm	ARO-0980NH3	
	Pilar Multi-Unit recto alt. 4,5mm	ARO-0980NH4	
	Pilar Multi-Unit recto alt. 5,5mm	ARO-0980NH5	
Pilar Multi-Unit recto alt. 6,5mm	ARO-0980NH6		
	Pilar Multi-Unit angul. 17° alt. 2,5mm	SIS-0940	SIS-0942
	Pilar Multi-Unit angul. 17° alt. 3,5mm	SIS-0941	SIS-0943
	Pilar Multi-Unit angul. 30° alt. 3,5mm	SIS-0944	SIS-0946
	Pilar Multi-Unit angul. 30° alt. 4,5mm	SIS-0945	SIS-0947
	Unigrip		
	SMART ANGLE		
	Tornillo Smart Angle	SIS-2017	SIS-2003
	Tornillo Smart Angle alt. 3mm/4mm	SIS-2017HG	SIS-2003HG
	17° 30° CALCINABLE ANGULADO PARA BASES Cr-Co		
	Chimenea ang. 17°	SIS-8207A	SIS-8207A
	Chimenea ang. 30°	SIS-8207B	SIS-8207B

F: 0900



STRAUMANN® BONE LEVEL®

Interna

NC 3.3

RC 4.1/4.8



Coping impresión (cubeta abierta)

Torx

SIS- 1127N

SIS- 1127R



Análogo

Tornillo fijación análogo digital

Plana/Cruz

SIS-1101N

SIS-1101

SIS-8888

SIS-8888



Tapón cicatrización alt. 2mm

Tapón cicatrización alt. 3,5mm

Tapón cicatrización alt. 5mm

Torx

SIS-1128N

SIS-1128R

SIS-1129N

SIS-1129R

SIS-1130N

SIS-1130R



Pilar recto antirotatorio

Pilar angulado 15°

Pilar angulado 25°

Pilar provisional rotatorio

Pilar provisional antirrotatorio

**Tornillos se venden por separado*

SIS-1115NA

SIS-1115RA

SIS-1182N

SIS-1182R

SIS-1183N

SIS-1183R

SIS-1107N

SIS-1107

SIS-1108N

SIS-1108



Ti-Base rotatoria

Ti-Base antirrotatoria

SIS-1108NR

SIS-1108RR

SIS-1108NA

SIS-1108RA



Ti-Base HG 2,5mm rotatoria

Ti-Base HG 2,5mm antirrotatoria

SIS-1108NRG2

SIS-1108RRG2

SIS-1108NAG2

SIS-1108RAG2



Ti-Base HG 3,5mm rotatoria

Ti-Base HG 3,5mm antirrotatoria

SIS-1108NRG3

SIS-1108RRG3

SIS-1108NAG3

SIS-1108RAG3



Ti-Base HG 4,5mm rotatoria

Ti-Base HG 4,5mm antirrotatoria

SIS-1108NRG4

SIS-1108RRG4

SIS-1108NAG4

SIS-1108RAG4



Ti-Base HC 7mm rotatoria

Ti-Base HC 7mm antirrotatoria

SIS-1108NRC7

SIS-1108RRC7

SIS-1108NAC7

SIS-1108RAC7



Ti-Base HG 2,5mm HC 7mm rotatoria

Ti-Base HG 2,5mm HC 7mm antirrotatoria

Ti-Base HG 3,5mm HC 7mm rotatoria

Ti-Base HG 3,5mm HC 7mm antirrotatoria

Ti-Base HG 4,5mm HC 7mm rotatoria

Ti-Base HG 4,5mm HC 7mm antirrotatoria

SIS-1108NRG2C7

SIS-1108RRG2C7

SIS-1108NAG2C7

SIS-1108RAG2C7

SIS-1108NRG3C7

SIS-1108RRG3C7

SIS-1108NAG3C7

SIS-1108RAG3C7

SIS-1108NRG4C7

SIS-1108RRG4C7

SIS-1108NAG4C7

SIS-1108RAG4C7



Ti-Base HC 9mm rotatoria (recortable)

Ti-Base HC 9mm antirrotatoria (recortable)

SIS-1108NRC9

SIS-1108RRC9

SIS-1108NAC9

SIS-1108RAC9

**Tornillos se venden por separado*



Scanbody (Ti)

**Tornillos se venden por separado*

SIS-1190NS

SIS-1190RS



Calcinable rotatorio

Calcinable antirrotatorio

Sobrecolable Cr-Co rotatorio

Sobrecolable Cr-Co antirrotatorio

**Tornillos se venden por separado*

SIS-1102N

SIS-1102

SIS-1103N

SIS-1103

SIS-1105N

SIS-1105

SIS-1106N

SIS-1106



STRAUMANN® BONE LEVEL®

Interna

		NC 3.3	RC 4.1/4.8
	Pilar SIScator alt. 1mm	SIS-1109N	SIS-1109R
	Pilar SIScator alt. 2mm	SIS-1110N	SIS-1110R
	Pilar SIScator alt. 3mm	SIS-1111N	SIS-1111R
	Pilar SIScator alt. 4mm	SIS-1112N	SIS-1112R
	Pilar SIScator alt. 5mm	SIS-1113N	SIS-1113R
	Pilar SIScator alt. 6mm	SIS-1114N	SIS-1114R
	Pilar SIScator angulado 15° alt. 1,5mm.	SIS-1117H1N	SIS-1117H1R
	Pilar SIScator angulado 15° alt. 3mm.	SIS-1117H3N	SIS-1117H3R
	Tornillo M1,6 (Torx)	SIS-1114RC	SIS-1114RC
	B TORNILLOS CON RECUBRIMIENTO BIOCARB Tornillo M1,6 (Torx)	SIS-1114RCB	SIS-1114RCB
	SIS MULTI-UNIT SIS Pilar Multi-Unit recto alt. 1,5mm	SIS-1123NC	SIS-1123RC
	Pilar Multi-Unit recto alt. 2,5mm	SIS-1124NC	SIS-1124RC
	Pilar Multi-Unit recto alt. 3,5mm	SIS-1125NC	SIS-1125RC
	Pilar Multi-Unit recto alt. 4,5mm	SIS-1126NC	SIS-1126RC
	mini MULTI-UNIT mini Pilar Multi-Unit recto alt. 1,5mm	ARO-1180NH1	
	Pilar Multi-Unit recto alt. 2,5mm	ARO-1180NH2	
	Pilar Multi-Unit recto alt. 3,5mm	ARO-1180NH3	
	Pilar Multi-Unit recto alt. 4,5mm	ARO-1180NH4	
	Pilar Multi-Unit angul. 17° alt. 2,5mm	SIS-1170NH2	SIS-1170RH2
	Pilar Multi-Unit angul. 17° alt. 3,5mm	SIS-1170NH3	SIS-1170RH3
	Pilar Multi-Unit angul. 30° alt. 3,5mm	SIS-1171NH3	SIS-1171RH3
	Pilar Multi-Unit angul. 30° alt. 4,5mm	SIS-1171NH4	SIS-1171RH4
	T Torx SMART ANGLE Tornillo Smart Angle Tornillo Smart Angle alt. 3mm/4mm	SIS-2009 SIS-2009HG	SIS-2009 SIS-2009HG
	17° 30° CALCINALBE ANGULADA PARA BASES Cr-Co Chimenea ang. 17°	SIS-8207A	SIS-8207A
	Chimenea ang. 30°	SIS-8207B	SIS-8207B

F: 1100

**BTI®**

Hexágono Externo



Coping impresión (cubeta abierta)

Hexagonal 1,20

NP 3.5

SIS-1201N

RP 4.1

SIS-0101



Análogo

Tornillo fijación análogo digital

Plana/Cruz

SIS-1201

SIS-0102

SIS-8888

SIS-8888



Tapón cicatrización alt. 2mm

Tapón cicatrización alt. 3mm

Tapón cicatrización alt. 4mm

Tapón cicatrización alt. 5mm

Tapón cicatrización alt. 6mm

Hexagonal 1,20/Plana

SIS-0104

SIS-0105

SIS-0106

SIS-0107

SIS-0108



Pilar recto rotatorio

Pilar recto antirrotatorio

Pilar angulado 15°

Pilar angulado 25°



Pilar provisional rotatorio

Pilar provisional antirrotatorio

**Tornillos se venden por separado*

SIS-1205NA

SIS-0188R

SIS-0109

SIS-0182

SIS-0183

SIS-1250NR

SIS-0162

SIS-1250NA

SIS-0164

SMART
TI-BASE

Ti-Base rotatoria

Ti-Base antirrotatoria

Ti-Base HG 2mm rotatoria

Ti-Base HG 2mm antirrotatoria

Ti-Base HG 3mm rotatoria

Ti-Base HG 3mm antirrotatoria

Ti-Base HC 7mm rotatoria

Ti-Base HC 7mm antirrotatoria

Ti-Base HG 2mm HC 7mm rotatoria

Ti-Base HG 2mm HC 7mm antirrotatoria

Ti-Base HG 3mm HC 7mm rotatoria

Ti-Base HG 3mm HC 7mm antirrotatoria

Ti-Base HC 9mm rotatoria (recortable)

Ti-Base HC 9mm antirrotatoria (recortable)

**Tornillos se venden por separado*

SIS-1208NR

SIS-0108RR

SIS-1208NA

SIS-0108RA

SIS-0108RRG2

SIS-0108RAG2

SIS-0108RRG3

SIS-0108RAG3

SIS-0108RRC7

SIS-0108RAC7

SIS-0108RRG2C7

SIS-0108RAG2C7

SIS-0108RRG3C7

SIS-0108RAG3C7

SIS-1208NRC9

SIS-0108RRC9

SIS-1208NAC9

SIS-0108RAC9



Scanbody (Ti)

**Tornillos se venden por separado*

SIS-1290N

SIS-0190R



Calcinable rotatorio

Calcinable antirrotatorio

Sobrecalable Cr-Co rotatorio

Sobrecalable Cr-Co antirrotatorio

**Tornillos se venden por separado*

SIS-1230NR

SIS-0110

SIS-1230NA

SIS-0111

SIS-0114

SIS-0115

**BTI®**

Hexágono Externo

		NP 3.5	RP 4.1
	Pilar SIScator alt. 0,73mm		SIS-0117
	Pilar SIScator alt. 2mm		SIS-0118
	Pilar SIScator alt. 3mm		SIS-0119
	Pilar SIScator alt. 4mm		SIS-0158
	Pilar SIScator alt. 5mm		SIS-0159
	Pilar SIScator alt. 6mm		SIS-0163
	Pilar SIScator angulado 15° alt. 1,5mm.		SIS-0117H1R
	Pilar SIScator angulado 15° alt. 3mm.		SIS-0117H3R
	Tornillo M2 (hex. 1,20)	SIS-1210	SIS-0152
	Tornillo M2 (hex. 1,25)		SIS-0153
	Tornillo M2 (hex. 1,20) rosca completa		SIS-0160
	Tornillo M2 (hex. 1,25) rosca completa		SIS-0161
	Tornillo M2 (unigrip)		SIS-0151
	Tornillo M2 (cuadrado 1,30)		SIS-0154
	B TORNILLOS RECUBRIMIENTO BIOCARB		
	Tornillo M2 (hex. 1,20)	SIS-1210B	SIS-0152B
	Tornillo M2 (hex. 1,25)		SIS-0153B
	Tornillo M2 (hex. 1,20) rosca completa		SIS-0160B
	Tornillo M2 (hex. 1,25) rosca completa		SIS-0161B
	Tornillo M2 (unigrip)		SIS-0151B
	SIS MULTI-UNIT SIS		
	Pilar Multi-Unit recto alt. 1mm		SIS-0160RH0C
	Pilar Multi-Unit recto alt. 1,5mm		SIS-0168C
	Pilar Multi-Unit recto alt. 2,5mm	SIS-1260NH2C	SIS-0169C
	Pilar Multi-Unit recto alt. 3,5mm	SIS-1260NH3C	SIS-0170C
	Pilar Multi-Unit recto alt. 4,5mm	SIS-1260NH4C	SIS-0171C
	Pilar Multi-Unit recto alt. 5,5mm		SIS-0172C
	Pilar Multi-Unit angul. 17° alt. 2mm		SIS-0176
	Pilar Multi-Unit angul. 17° alt. 3mm		SIS-0177
	Pilar Multi-Unit angul. 17° alt. 4mm		SIS-0178
	Pilar Multi-Unit angul. 30° alt. 3mm		SIS-0179
	Pilar Multi-Unit angul. 30° alt. 4mm		SIS-0180
	Pilar Multi-Unit angul. 30° alt. 5mm		SIS-0181
 Unigrip			
	SMART ANGLE		
	Tornillo Smart Angle	SIS-2026	SIS-2001
	Tornillo Smart Angle alt. 3mm/4mm		SIS-2001HG
	CALCINABLE ANGULADO PARA BASES Cr-Co		
	Chimenea ang. 17°	SIS-8207A	SIS-8207A
	Chimenea ang. 30°	SIS-8207B	SIS-8207B

F: 0120/0100



SWEDEN & MARTINA® PREMIUM KOHNO®

Interna

	3.3	3.8	4.2
 <p>Coping impresión (cubeta abierta) ① Hexagonal 1,27</p>	SIS-1437	SIS-1438	SIS-1439
 <p>Análogo Tornillo fijación análogo digital ① Plana/Cruz</p>	SIS-1406 SIS-8888	SIS-1401N SIS-8888	SIS-1401 SIS-8888
 <p>Tapón cicatrización alt. 2mm Tapón cicatrización alt. 3mm Tapón cicatrización alt. 4mm Tapón cicatrización alt. 5mm ① Hexagonal 1,27</p>	SIS-1449 SIS-1450 SIS-1451 SIS-1452	SIS-1453 SIS-1454 SIS-1455 SIS-1456	SIS-1457 SIS-1458 SIS-1459 SIS-1460
 <p>Pilar recto antirrotatorio Pilar angulado 15° Pilar angulado 25° Pilar provisional rotatorio Pilar provisional antirrotatorio *Tornillos se venden por separado</p>	SIS-1405XA SIS-1482X SIS-1483X SIS-1409 SIS-1410	SIS-1402N SIS-1483N SIS-1450RN SIS-1450AN	SIS-1402 SIS-1482R SIS-1483R SIS-1413 SIS-1414
  <p>Ti-Base rotatoria Ti-Base antirrotatoria</p>	SIS-1408XR SIS-1408XA	SIS-1408NR SIS-1408NA	SIS-1408RR SIS-1408RA
 <p>Ti-Base HG 2mm rotatoria Ti-Base HG 2mm antirrotatoria Ti-Base HG 3mm rotatoria Ti-Base HG 3mm antirrotatoria Ti-Base HG 4mm rotatoria Ti-Base HG 4mm antirrotatoria</p>		SIS-1408NRG2 SIS-1408NAG2 SIS-1408NRG3 SIS-1408NAG3 SIS-1408NRG4 SIS-1408NAG4	
 <p>Ti-Base HC 9mm rotatoria (recortable) Ti-Base HC 9mm antirrotatoria (recortable) *Tornillos se venden por separado</p>	SIS-1408XRC9 SIS-1408XAC9	SIS-1408NRC9 SIS-1408NAC9	SIS-1408RRC9 SIS-1408RAC9
 <p>Scanbody (Ti) *Tornillos se venden por separado</p>	SIS-1490X	SIS-1490N	SIS-1490R
 <p>Calcinable rotatorio Calcinable antirrotatorio Sobrecolable Cr-Co rotatorio Sobrecolable Cr-Co antirrotatorio *Tornillos se venden por separado</p>	SIS-1407 SIS-1408 SIS-1411 SIS-1412	SIS-1403N SIS-1404N SIS-1461 SIS-1462	SIS-1403 SIS-1404 SIS-1415 SIS-1416

F: 1400



SWEDEN & MARTINA® PREMIUM KOHNO®

Interna

		3.3	3.8	4.25
	Pilar SIScator alt. 1mm	SIS-1417	SIS-1420	SIS-1424
	Pilar SIScator alt. 2mm	SIS-1418	SIS-1421	SIS-1425
	Pilar SIScator alt. 3mm	SIS-1419	SIS-1422	SIS-1426
	Pilar SIScator alt. 4mm	SIS-1463	SIS-1423	SIS-1427
	Pilar SIScator alt. 5mm	SIS-1464	SIS-1465	SIS-1466
	Tornillo M1,8 (hex. 1,27)	SIS-1405N	SIS-1405N	
	Tornillo M2 (hex. 1,27)			SIS-1405
	B TORNILLOS RECUBRIMIENTO BIOCARB			
	Tornillo M1,8 (hex. 1,27)	SIS-1405NB	SIS-1405NB	
	Tornillo M2 (hex. 1,27)			SIS-1405B
	SIS MULTI-UNIT SIS			
	Pilar Multi-Unit recto alt. 1,5mm	SIS-1446C	SIS-1447C	SIS-1448C
	Pilar Multi-Unit recto alt. 2,5mm	SIS-1428C	SIS-1431C	SIS-1434C
	Pilar Multi-Unit recto alt. 3,5mm	SIS-1429C	SIS-1432C	SIS-1435C
	Pilar Multi-Unit recto alt. 4,5mm	SIS-1430C	SIS-1433C	SIS-1436C
	Pilar Multi-Unit recto alt. 5,5mm		SIS-1460NH5C	SIS-1460RH5C
	Pilar Multi-Unit recto alt. 6,5mm		SIS-1460NH6C	SIS-1460RH6C
	Pilar Multi-Unit angul. 17° alt. 2,5mm	SIS-1470XH25	SIS-1470NH25	SIS-1470RH25
	Pilar Multi-Unit angul. 17° alt. 3,5mm	SIS-1470XH35	SIS-1470NH35	SIS-1470RH35
	Pilar Multi-Unit angul. 17° alt. 4,5mm	SIS-1470XH45	SIS-1470NH45	SIS-1470RH45
	Pilar Multi-Unit angul. 30° alt. 3,5mm	SIS-1471XH35	SIS-1471NH35	SIS-1471RH35
	Pilar Multi-Unit angul. 30° alt. 4,5mm	SIS-1471XH45	SIS-1471NH45	SIS-1471RH45
	H Hexagonal 1,27			
	SMART ANGLE			
	Tornillo Smart Angle	SIS-2021	SIS-2021	SIS-2016
	Tornillo Smart Angle alt. 3mm/4mm		SIS-2021HG	
	CALCINABLE ANGULADO PARA BASES Cr-Co			
	Chimenea ang. 17°	SIS-8207A	SIS-8207A	SIS-8207A
	Chimenea ang. 30°	SIS-8207B	SIS-8207B	SIS-8207B

	NP 3.3	RP 4.0	WP 5.0	
Coping impresión (cubeta abierta)	SIS-1501	SIS-0101	SIS-1501W	
 Análogo Tornillo fijación análogo digital Ⓜ Plana/Cruz	SIS-1502	SIS-0102	SIS-1506	
	SIS-8888	SIS-8888	SIS-8888	
 Tapón cicatrización alt. 2mm Tapón cicatrización alt. 3mm Tapón cicatrización alt. 4mm Tapón cicatrización alt. 5mm Tapón cicatrización alt. 6mm Ⓜ Hexagonal 1,20		SIS-0104		
		SIS-0105		
		SIS-0106		
		SIS-0107		
		SIS-0108		
        *Tornillos se venden por separado		SIS-0188R		
		SIS-1505XA	SIS-0109	SIS-1505WA
			SIS-0182	
			SIS-0183	
		SIS-1550XR	SIS-0162	SIS-1550WR
		SIS-1550XA	SIS-0164	SIS-1550WA
			SIS-0190	
			SIS-0191	
           *Tornillos se venden por separado	SIS-1508NR	SIS-0108RR	SIS-1508WR	
		SIS-1508NA	SIS-0108RA	SIS-1508WA
			SIS-0108RRG2	
			SIS-0108RAG2	
			SIS-0108RRG3	
			SIS-0108RAG3	
			SIS-0108RRC7	
			SIS-0108RAC7	
			SIS-0108RRG2C7	
			SIS-0108RAG2C7	
			SIS-0108RRG3C7	
			SIS-0108RAG3C7	
		SIS-1508NRC9	SIS-0108RRC9	SIS-1508WRC9
		SIS-1508NAC9	SIS-0108RAC9	SIS-1508WAC9
	 Scanbody (Ti) *Tornillos se venden por separado	SIS-1590N	SIS-0190R	SIS-1590W
  *Tornillos se venden por separado		SIS-0110		
			SIS-0111	
		SIS-1530NR	SIS-0114	SIS-1530WR
		SIS-1530NA	SIS-0115	SIS-1530WA



PHIBO® TSH®

Hexágono Externo

		NP 3.3	RP 4.0	WP 5.0
	Pilar SISCator alt. 0,73mm		SIS-0117	
	Pilar SISCator alt. 2mm		SIS-0118	
	Pilar SISCator alt. 3mm		SIS-0119	
	Pilar SISCator alt. 4mm		SIS-0158	
	Pilar SISCator alt. 5mm		SIS-0159	
	Pilar SISCator alt. 6mm		SIS-0163	
		Pilar SISCator angulado 15° alt. 1,5mm.		SIS-0117H1R
Pilar SISCator angulado 15° alt. 3mm.			SIS-0117H3R	
	Tornillo M1,8 (hex. 1,25)	SIS-1505		
	Tornillo M2 (hex. 1,20)		SIS-0152	SIS-0152
	Tornillo M2 (hex. 1,25)		SIS-0153	SIS-0153
	Tornillo M2 (hex. 1,20) rosca completa		SIS-0160	SIS-0160
	Tornillo M2 (hex. 1,25) rosca completa		SIS-0161	SIS-0161
	Tornillo M2 (unigrip)		SIS-0151	SIS-0151
	Tornillo M2 (cuadrado 1,30)		SIS-0154	SIS-0154
	B TORNILLOS CON BIOCARB			
	Tornillo M1,8 (hex. 1,25)	SIS-1505B		
	Tornillo M2 (hex. 1,20)		SIS-0152B	SIS-0152B
	Tornillo M2 (hex. 1,25)		SIS-0153B	SIS-0153B
	Tornillo M2 (hex. 1,20) rosca completa		SIS-0160B	SIS-0160B
	Tornillo M2 (hex. 1,25) rosca completa		SIS-0161B	SIS-0161B
	Tornillo M2 (unigrip)		SIS-0151B	SIS-0151B
	Tornillo M2 (cuadrado 1,30)		SIS-0154B	SIS-0154B
	SIS MULTI-UNIT SIS			
	Pilar Multi-Unit recto alt. 1mm		SIS-0160RH0C	
	Pilar Multi-Unit recto alt. 1,5mm	SIS-1560XH1C	SIS-0168C	SIS-1560WH1C
	Pilar Multi-Unit recto alt. 2,5mm	SIS-1560XH2C	SIS-0169C	SIS-1560WH2C
	Pilar Multi-Unit recto alt. 3,5mm	SIS-1560XH3C	SIS-0170C	SIS-1560WH3C
	Pilar Multi-Unit recto alt. 4,5mm	SIS-1560XH4C	SIS-0171C	SIS-1560WH4C
	Pilar Multi-Unit recto alt. 5,5mm	SIS-1560XH5C	SIS-0172C	SIS-1560WH5C
	Pilar Multi-Unit angul. 17° alt. 2mm		SIS-0176	
	Pilar Multi-Unit angul. 17° alt. 3mm		SIS-0177	
	Pilar Multi-Unit angul. 17° alt. 4mm		SIS-0178	
	Pilar Multi-Unit angul. 30° alt. 3mm		SIS-0179	
	Pilar Multi-Unit angul. 30° alt. 4mm		SIS-0180	
	Pilar Multi-Unit angul. 30° alt. 5mm		SIS-0181	
	Unigrip			
	IMPLANTES ZIGOMÁTICOS			
	Pilar Multi-Unit recto alt. 1mm		SIS-0168Z	
Pilar Multi-Unit recto alt. 2mm		SIS-0169Z		
	SMART ANGLE			
	Tornillo Smart Angle	SIS-2024	SIS-2027 SIS-2001HG	SIS-2027
Tornillo Smart Angle alt. 3mm/4mm				
	CHIMENEAS ANGULADAS PARA BASES DE Cr-Co			
	Chimenea ang. 17°	SIS-8207A	SIS-8207A	SIS-8207A
	Chimenea ang. 30°	SIS-8207B	SIS-8207B	SIS-8207B



BIOHORIZONS® TAPERED®

Hexágono Interno

	3.0	3.5	4.5
Coping impresión (cubeta abierta) Hexagonal 1,27	SIS-1601N	SIS-1601R	SIS-0301
Análogo	SIS-1602N	SIS-1602R	SIS-0302
Tornillo fijación análogo digital Plana/Cruz	SIS-8888	SIS-8888	SIS-8888
Tapón cicatrización alt. 2mm	SIS-1604NH2	SIS-1604RH2	SIS-0304
Tapón cicatrización alt. 3mm	SIS-1604NH3	SIS-1604RH3	SIS-0305
Tapón cicatrización alt. 4mm	SIS-1604NH4	SIS-1604RH4	SIS-0306
Tapón cicatrización alt. 5mm Hexagonal 1,27	SIS-1604NH5	SIS-1604RH5	SIS-0307
Pilar recto antirrotatorio alt. 1mm	SIS-1605NA	SIS-1605RA	SIS-0309H1
Pilar provisional rotatorio	SIS-1650NR	SIS-1650RR	SIS-0350RR
Pilar provisional antirrotatorio <i>*Tornillos se venden por separado</i>	SIS-1650NA	SIS-1650RA	SIS-0350RA
SMART Ti-BASE Ti-Base rotatoria	SIS-1608NR	SIS-1608RR	SIS-0308RR
Ti-Base antirrotatoria	SIS-1608NA	SIS-1608RA	SIS-0308RA
Ti-Base HG 2mm rotatoria	SIS-1608NRG2	SIS-1608RRG2	
Ti-Base HG 2mm antirrotatoria	SIS-1608NAG2	SIS-1608RAG2	
Ti-Base HG 3mm rotatoria	SIS-1608NRG3	SIS-1608RRG3	
Ti-Base HG 3mm antirrotatoria	SIS-1608NAG3	SIS-1608RAG3	
Ti-Base HG 4mm rotatoria	SIS-1608NRG4	SIS-1608RRG4	
Ti-Base HG 4mm antirrotatoria	SIS-1608NAG4	SIS-1608RAG4	
Ti-Base HC 7mm rotatoria	SIS-1608NRC7	SIS-1608RRC7	
Ti-Base HC 7mm antirrotatoria	SIS-1608NAC7	SIS-1608RAC7	
Ti-Base HG 2mm HC 7mm rotatoria	SIS-1608NRG2C7	SIS-1608RRG2C7	
Ti-Base HG 2mm HC 7mm antirrotatoria	SIS-1608NAG2C7	SIS-1608RAG2C7	
Ti-Base HG 3mm HC 7mm rotatoria	SIS-1608NRG3C7	SIS-1608RRG3C7	
Ti-Base HG 3mm HC 7mm antirrotatoria	SIS-1608NAG3C7	SIS-1608RAG3C7	
Ti-Base HG 4mm HC 7mm rotatoria	SIS-1608NRG4C7	SIS-1608RRG4C7	
Ti-Base HG 4mm HC 7mm antirrotatoria	SIS-1608NAG4C7	SIS-1608RAG4C7	
Ti-Base HC 9mm rotatoria (recortable)	SIS-1608NRC9	SIS-1608RRC9	SIS-0308RRC9
Ti-Base HC 9mm antirrotatoria (recortable) <i>*Tornillos se venden por separado</i>	SIS-1608NAC9	SIS-1608RAC9	SIS-0308RAC9
Scanbody (Ti) <i>*Tornillos se venden por separado</i>	SIS-1690N	SIS-1690R	SIS-0390R
Sobrecolable Cr-Co rotatorio	SIS-1630NR	SIS-1630RR	SIS-0314
Sobrecolable Cr-Co antirrotatorio <i>*Tornillos se venden por separado</i>	SIS-1630NA	SIS-1630RA	SIS-0315



BIOHORIZONS® TAPERED®

Hexágono Interno

		3.0	3.5	4.5
	Pilar SIScator alt. 1mm	SIS-1610NH1	SIS-1610RH1	SIS-0317
	Pilar SIScator alt. 2mm	SIS-1610NH2	SIS-1610RH2	SIS-0318
	Pilar SIScator alt. 3mm	SIS-1610NH3	SIS-1610RH3	SIS-0319
	Pilar SIScator alt. 4mm	SIS-1610NH4	SIS-1610RH4	SIS-0352
	Pilar SIScator alt. 5mm	SIS-1610NH5	SIS-1610RH5	SIS-0358
	Pilar SIScator alt. 6mm	SIS-1610NH6	SIS-1610RH6	SIS-0360
	Pilar SIScator angulado 15° alt. 1.5mm.		SIS-1617H1R	SIS-0317H1R
	Pilar SIScator angulado 15° alt. 3mm.		SIS-1617H3R	SIS-0317H3R
	Tornillo UNF 1/72 (hex. 1,27)	SIS-1614N	SIS-1614N	SIS-0351M
	B TORNILLOS RECUBRIMIENTO BIOCARB Tornillo UNF 1/72 (hex. 1,27)		SIS-1614NB	SIS-0351MB
	SIS MULTI-UNIT SIS Pilar Multi-Unit recto alt. 1,5mm	SIS-1660NH1C	SIS-1660RH1C	SIS-0366C
	Pilar Multi-Unit recto alt. 2,5mm	SIS-1660NH2C	SIS-1660RH2C	SIS-0367C
	Pilar Multi-Unit recto alt. 3,5mm	SIS-1660NH3C	SIS-1660RH3C	SIS-0368C
	Pilar Multi-Unit recto alt. 4,5mm	SIS-1660NH4C	SIS-1660RH4C	SIS-0369C
	Pilar Multi-Unit recto alt. 5,5mm	SIS-1660NH5C	SIS-1660RH5C	SIS-0370C
	Pilar Multi-Unit recto alt. 6,5mm		SIS-1660RH6C	SIS-0360RH6C
	mini MULTI-UNIT mini Pilar Multi-Unit recto alt. 1,5mm	ARO-1680NH1	ARO-1680RH1	
	Pilar Multi-Unit recto alt. 2,5mm	ARO-1680NH2	ARO-1680RH2	
	Pilar Multi-Unit recto alt. 3,5mm	ARO-1680NH3	ARO-1680RH3	
	Pilar Multi-Unit recto alt. 4,5mm	ARO-1680NH4	ARO-1680RH4	
	Pilar Multi-Unit recto alt. 5,5mm	ARO-1680NH5	ARO-1680RH5	
	Pilar Multi-Unit recto alt. 6,5mm	ARO-1680NH6	ARO-1680RH6	
	Pilar Multi-Unit angul. 17° alt. 2,5mm	SIS-1670NH2	SIS-0371	SIS-0376
	Pilar Multi-Unit angul. 17° alt. 3,5mm	SIS-1670NH3	SIS-0372	SIS-0377
	Pilar Multi-Unit angul. 30° alt. 3,5mm	SIS-1671NH3	SIS-0373	SIS-0378
	Pilar Multi-Unit angul. 30° alt. 4,5mm	SIS-1671NH4	SIS-0374	SIS-0379
	H Hexagonal 1,27			
	SMART ANGLE Tornillo Smart Angle	SIS-1615N	SIS-1615N	SIS-2007M
	Tornillo Smart Angle alt. 3mm/4mm	SIS-1615NHG	SIS-1615NHG	
	CHIMENEAS ANGULADAS PARA BASES DE Cr-Co Chimenea ang. 17°	SIS-8217A	SIS-8207A	SIS-8207A
	Chimenea ang. 25°	SIS-8217B		
	Chimenea ang. 30°		SIS-8207B	SIS-8207B

F: 1600



MIS® C1/V3

Hexágono Cónico Interno

RP



Coping impresión (cubeta abierta)

Hexagonal 1,27

SIS-1801R



Análogo

Tornillo fijación análogo digital

Plana/Cruz

SIS-1802

SIS-8888



Tapón cicatrización alt. 2mm

Tapón cicatrización alt. 3mm

Tapón cicatrización alt. 4mm

Tapón cicatrización alt. 5mm

Hexagonal 1,27

SIS-1804RH2

SIS-1804RH3

SIS-1804RH4

SIS-1804RH5



Pilar recto antirrotatorio

Pilar provisional rotatorio

Pilar provisional antirrotatorio

*Tornillos se venden por separado

SIS-1806

SIS-1850RR

SIS-1850RA

SMART
Ti-BASE



Ti-Base rotatoria

SIS-1808RR

Ti-Base antirrotatoria

SIS-1808RA



Ti-Base HG 2,5mm rotatoria

SIS-1808RRG2

Ti-Base HG 2,5mm antirrotatoria

SIS-1808RAG2

Ti-Base HG 3,5mm rotatoria

SIS-1808RRG3

Ti-Base HG 3,5mm antirrotatoria

SIS-1808RAG3

Ti-Base HG 4,5mm rotatoria

SIS-1808RRG4

Ti-Base HG 4,5mm antirrotatoria

SIS-1808RAG4



Ti-Base HC 7mm rotatoria

SIS-1808RRC7

Ti-Base HC 7mm antirrotatoria

SIS-1808RAC7



Ti-Base HG 2,5mm HC 7mm rotatoria

SIS-1808RRG2C7

Ti-Base HG 2,5mm HC 7mm antirrotatoria

SIS-1808RAG2C7

Ti-Base HG 3,5mm HC 7mm rotatoria

SIS-1808RRG3C7

Ti-Base HG 3,5mm HC 7mm antirrotatoria

SIS-1808RAG3C7

Ti-Base HG 4,5mm HC 7mm rotatoria

SIS-1808RRG4C7

Ti-Base HG 4,5mm HC 7mm antirrotatoria

SIS-1808RAG4C7



Ti-Base HC 9mm rotatoria (recortable)

SIS-1808RRC9

Ti-Base HC 9mm antirrotatoria (recortable)

SIS-1808RAC9

*Tornillos se venden por separado



Scanbody (Ti)

SIS-1890R

*Tornillos se venden por separado



Sobrecolable Cr-Co rotatorio

SIS-1808

Sobrecolable Cr-Co antirrotatorio



SIS-1807

*Tornillos se venden por separado



MIS® C1/V3

Hexágono Cónico Interno

		RP
	Pilar SIScator alt. 1mm	SIS-1810RH1
	Pilar SIScator alt. 2mm	SIS-1810RH2
	Pilar SIScator alt. 3mm	SIS-1810RH3
	Pilar SIScator alt. 4mm	SIS-1810RH4
	Pilar SIScator alt. 5mm	SIS-1810RH5
	Tornillo UNF 1/72 (hex. 1,25)	SIS-0351M
	 TORNILLOS CON RECUBRIMIENTO BIOCARB Tornillo UNF 1/72 (hex. 1,25)	SIS-0351MB
	 MULTI-UNIT SIS Pilar Multi-Unit recto alt. 1mm	SIS-1860RH0C
	Pilar Multi-Unit recto alt. 1,5mm	SIS-1860RH1C
	Pilar Multi-Unit recto alt. 2,5mm	SIS-1860RH2C
	Pilar Multi-Unit recto alt. 3,5mm	SIS-1860RH3C
	Pilar Multi-Unit recto alt. 4,5mm	SIS-1860RH4C
	Pilar Multi-Unit recto alt. 5,5mm	SIS-1860RH5C
	Pilar Multi-Unit recto alt. 6,5mm	SIS-1860RH6C
	SMART ANGLE Tornillo Smart Angle	SIS-2007M
	Tornillo Smart Angle alt. 3mm/4mm	SIS-2007MHG
	CHIMENEAS ANGULADAS PARA BASES DE Cr-Co Chimenea ang. 17°	SIS-8218A
	Chimenea ang. 25°	SIS-8218B



NEOBIOTECH® IS SYSTEM

Cónica Interna

REGULAR



Coping impresión (cubeta abierta)

Hexagonal 1,20

SIS-2201R



Análogo

Tornillo fijación análogo digital

Plana/Cruz

SIS-2202R

SIS-8888



Tapón cicatrización alt. 3mm

Tapón cicatrización alt. 4mm

Tapón cicatrización alt. 5mm

Tapón cicatrización alt. 7mm

Hexagonal 1,20

SIS-2204RH3

SIS-2204RH4

SIS-2204RH5

SIS-2204RH7



Pilar recto antirrotatorio

Pilar angulado 15°

Pilar angulado 25°

Pilar provisional rotatorio

Pilar provisional antirrotatorio

SIS-2205RA

SIS-2282R

SIS-2283R

SIS-2250RR

SIS-2250RA

**Tornillos se venden por separado*

SMART
TI-BASE



Ti-Base rotatoria

Ti-Base antirrotatoria

SIS-2208RR

SIS-2208RA



Ti-Base HG 2,5mm rotatoria

Ti-Base HG 2,5mm antirrotatoria

Ti-Base HG 3,5mm rotatoria

Ti-Base HG 3,5mm antirrotatoria

SIS-2208RRG2

SIS-2208RAG2

SIS-2208RRG3

SIS-2208RAG3



Ti-Base HG 4,5mm rotatoria

Ti-Base HG 4,5mm antirrotatoria

Ti-Base HC 9mm rotatoria (recortable)

Ti-Base HC 9mm antirrotatoria (recortable)

SIS-2208RRG4

SIS-2208RAG4

SIS-2208RRC9

SIS-2208RAC9

**Tornillos se venden por separado*



Scanbody (Ti)

SIS-2290R

**Tornillos se venden por separado*



Sobrecolable Cr-Co rotatorio

Sobrecolable Cr-Co antirrotatorio

SIS-2230RR

SIS-2230RA

**Tornillos se venden por separado*



NEOBIOTECH® IS SYSTEM

Cónica Interna

REGULAR



Pilar SIScator alt. 1mm

SIS-2210RH1

Pilar SIScator alt. 2mm

SIS-2210RH2

Pilar SIScator alt. 3mm

SIS-2210RH3

Pilar SIScator alt. 4mm

SIS-2210RH4

Pilar SIScator alt. 5mm

SIS-2210RH5

Pilar SIScator alt. 6mm

SIS-2210RH6



Pilar SIScator angulado 15° alt. 1,5mm.

SIS-2217H1R

Pilar SIScator angulado 15° alt. 3mm.

SIS-2217H3R



Tornillo M2 (hex. 1,20)

SIS-2214R



TORNILLOS CON RECUBRIMIENTO BIOCARB

Tornillo M2 (hex. 1,20)

SIS-2214RB



MULTIUNITSIS



Pilar Multi-Unit recto alt. 1,5mm

SIS-2260RH1C

Pilar Multi-Unit recto alt. 2,5mm

SIS-2260RH2C

Pilar Multi-Unit recto alt. 3,5mm

SIS-2260RH3C

Pilar Multi-Unit recto alt. 4,5mm

SIS-2260RH4C

Pilar Multi-Unit recto alt. 5,5mm

SIS-2260RH5C

Pilar Multi-Unit recto alt. 6,5mm

SIS-2260RH6C



Pilar Multi-Unit angul. 17° alt. 2,5mm

SIS-2870RH25

Pilar Multi-Unit angul. 17° alt. 3,5mm

SIS-2870RH35

Pilar Multi-Unit angul. 30° alt. 3,5mm

SIS-2871RH35

Pilar Multi-Unit angul. 30° alt. 4,5mm

SIS-2871RH45

Hexagonal 1,20



SMART ANGLE

Tornillo Smart Angle

SIS-2215R

Tornillo Smart Angle alt. 3mm/4mm

SIS-2215RHG



CHIMENEAS ANGULADAS PARA BASES DE Cr-Co

Chimenea ang. 17°

SIS-8219A

Chimenea ang. 25°

SIS-8219B



ASTRA® TECH SYSTEM™ EVOLUTION®

Cónica Interna

(*4.8 SOLO BAJO PEDIDO)

	3.0	3.6	4.2	4.8
 Pilar SIScator alt. 1mm		SIS-2310RH1	SIS-2310WH1	SIS-2310LH1
Pilar SIScator alt. 2mm		SIS-2310RH2	SIS-2310WH2	SIS-2310LH2
Pilar SIScator alt. 3mm		SIS-2310RH3	SIS-2310WH3	SIS-2310LH3
Pilar SIScator alt. 4mm		SIS-2310RH4	SIS-2310WH4	SIS-2310LH4
Pilar SIScator alt. 5mm		SIS-2310RH5	SIS-2310WH5	SIS-2310LH5
Pilar SIScator alt. 6mm		SIS-2310RH6	SIS-2310WH6	SIS-2310LH6
 Tornillo M1,4 (hex. 1,27)	SIS-2314X			
Tornillo M1,6 (hex. 1,27)		SIS-2314R		
Tornillo M1,8 (hex. 1,27)			SIS-2314W	
Tornillo M2 (hex. 1,27)				SIS-2314L
 B TORNILLOS RECUBRIMIENTO BIOCARB				
Tornillo M1,4 (hex. 1,27)	SIS-2314XB			
Tornillo M1,6 (hex. 1,27)		SIS-2314RB		
Tornillo M1,8 (hex. 1,27)			SIS-2314WB	
Tornillo M2 (hex. 1,27)				SIS-2314LB
 SIS MULTI-UNIT SIS				
Pilar Multi-Unit recto alt. 1,5mm		SIS-2360RH1C	SIS-2360WH1C	
Pilar Multi-Unit recto alt. 2,5mm		SIS-2360RH2C	SIS-2360WH2C	
Pilar Multi-Unit recto alt. 3,5mm		SIS-2360RH3C	SIS-2360WH3C	
Pilar Multi-Unit recto alt. 4,5mm		SIS-2360RH4C	SIS-2360WH4C	
Pilar Multi-Unit recto alt. 5,5mm		SIS-2360RH5C	SIS-2360WH5C	
Pilar Multi-Unit recto alt. 6,5mm		SIS-2360RH6C	SIS-2360WH6C	
 Pilar Multi-Unit angul. 17° alt. 2,5mm		SIS-2370RH2	SIS-2370WH2	
Pilar Multi-Unit angul. 17° alt. 3,5mm		SIS-2370RH3	SIS-2370WH3	
Pilar Multi-Unit angul. 30° alt. 3,5mm		SIS-2371RH3	SIS-2371WH3	
Pilar Multi-Unit angul. 30° alt. 4,5mm		SIS-2371RH4	SIS-2371WH4	
 H Hexagonal 1,27				
 SMART ANGLE				
Tornillo Smart Angle	SIS-2315X	SIS-2315R	SIS-2315W	SIS-2315L
Tornillo Smart Angle alt. 3mm/4mm	SIS-2315XHG	SIS-2315RHG	SIS-2315WHG	SIS-2315LHG
  CHIMENEAS CALCINABLE PARA BASES Cr-Co				
Chimenea ang. 17°		SIS-8220A	SIS-8221A	
Chimenea ang. 30°		SIS-8220B	SIS-8221B	

F: 2300



NEODENT GM® (HELIX GM®, DRIVE GM®, TITAMAX GM®)

Cónica Interna

STD



Coping impresión (cubeta abierta)

Neo

SIS-2401R



Análogo

Tornillo fijación análogo digital

Plana/Cruz

SIS-2402R

SIS-8888



Tapón cicatrización alt. 2,5mm

Tapón cicatrización alt. 3,5mm

Tapón cicatrización alt. 4,5mm

Tapón cicatrización alt. 5,5mm

Neo

SIS-2404RH2

SIS-2404RH3

SIS-2404RH4

SIS-2404RH5



Pilar recto antirrotatorio

Pilar provisional rotatorio

Pilar provisional antirrotatorio

**Tornillos se venden por separado*

SIS-2405RA

SIS-2450RR

SIS-2450RA

SMART
TI-BASE



Ti-Base rotatoria

Ti-Base antirrotatoria

SIS-2408RR

SIS-2408RA



Ti-Base HG 2,5mm rotatoria

Ti-Base HG 2,5mm antirrotatoria

Ti-Base HG 3,5mm rotatoria

Ti-Base HG 3,5mm antirrotatoria

Ti-Base HG 4,5mm rotatoria

Ti-Base HG 4,5mm antirrotatoria

SIS-2408RRG2

SIS-2408RAG2

SIS-2408RRG3

SIS-2408RAG3

SIS-2408RRG4

SIS-2408RAG4



Ti-Base HC 7mm rotatoria

Ti-Base HC 7mm antirrotatoria

SIS-2408RRC7

SIS-2408RAC7



Ti-Base HG 2,5mm HC 7mm rotatoria

Ti-Base HG 2,5mm HC 7mm antirrotatoria

Ti-Base HG 3,5mm HC 7mm rotatoria

Ti-Base HG 3,5mm HC 7mm antirrotatoria

Ti-Base HG 4,5mm HC 7mm rotatoria

Ti-Base HG 4,5mm HC 7mm antirrotatoria

SIS-2408RRG2C7

SIS-2408RAG2C7

SIS-2408RRG3C7

SIS-2408RAG3C7

SIS-2408RRG4C7

SIS-2408RAG4C7



Ti-Base HC 9mm rotatoria (recortable)

Ti-Base HC 9mm antirrotatoria (recortable)

**Tornillos se venden por separado*

SIS-2408RRC9

SIS-2408RAC9



Scanbody (Ti)

**Tornillos se venden por separado*

SIS-2490R



Sobrecolable Cr-Co rotatorio

Sobrecolable Cr-Co antirrotatorio

**Tornillos se venden por separado*







SIS-2430RR

SIS-2430RA



NEODENT GM® (HELIX GM®, DRIVE GM®, TITAMAX GM®)

Cónica Interna

		STD
	Pilar SISCator alt. 1mm	SIS-2410RH1
	Pilar SISCator alt. 2mm	SIS-2410RH2
	Pilar SISCator alt. 3mm	SIS-2410RH3
	Pilar SISCator alt. 4mm	SIS-2410RH4
	Pilar SISCator alt. 5mm	SIS-2410RH5
Pilar SISCator angulado 15° alt. 1,5mm.		SIS-2417H1R
Pilar SISCator angulado 15° alt. 3mm.		SIS-2417H3R
	Tornillo M1,6 (Neo)	SIS-2414R
	B TORNILLOS CON RECUBRIMIENTO BIOCARB Tornillo M1,6 (Neo)	SIS-2414RB
	SIS MULTI-UNIT SIS Pilar Multi-Unit recto alt. 1mm	SIS-2460RH0C
	Pilar Multi-Unit recto alt. 1,5mm	SIS-2460RH1C
	Pilar Multi-Unit recto alt. 2,5mm	SIS-2460RH2C
	Pilar Multi-Unit recto alt. 3,5mm	SIS-2460RH3C
	Pilar Multi-Unit recto alt. 4,5mm	SIS-2460RH4C
	Pilar Multi-Unit recto alt. 5,5mm	SIS-2460RH5C
	Pilar Multi-Unit angul. 17° alt. 2,5mm	SIS-2470RH2
	Pilar Multi-Unit angul. 17° alt. 3,5mm	SIS-2470RH3
	Pilar Multi-Unit angul. 30° alt. 3,5mm	SIS-2471RH3
	Pilar Multi-Unit angul. 30° alt. 4,5mm	SIS-2471RH4
	i Neo	
	SMART ANGLE Tornillo Smart Angle	SIS-2415R
	Tornillo Smart Angle alt. 3mm/4mm	SIS-2415RHG
	CHIMENEAS ANGULADAS PARA BASES DE Cr-Co Chimenea ang. 17°	SIS-8208A
	Chimenea ang. 30°	SIS-8208B



MEGAGEN ANYRIDGE®

Cónica Interna

STD



Coping impresión (cubeta abierta)

Hexagonal 1,20

SIS-2501R



Análogo

Tornillo fijación análogo digital

Plana/Cruz

SIS-2502R

SIS-8888



Tapón cicatrización alt. 2mm

Tapón cicatrización alt. 3mm

Tapón cicatrización alt. 4mm

Tapón cicatrización alt. 5mm

Hexagonal 1,20

SIS-2504RH2

SIS-2504RH3

SIS-2504RH4

SIS-2504RH5



Pilar recto antirrotatorio

Pilar angulado 15°

Pilar angulado 25°

Pilar provisional rotatorio

Pilar provisional antirrotatorio

**Tornillos se venden por separado*

SIS-2505RA

SIS-2582R

SIS-2583R

SIS-2550RR

SIS-2550RA

SMART
TI-BASE



Ti-Base rotatoria

Ti-Base antirrotatoria

Ti-Base HG 2,5mm rotatoria

Ti-Base HG 2,5mm antirrotatoria

Ti-Base HG 3,5mm rotatoria

Ti-Base HG 3,5mm antirrotatoria

Ti-Base HG 4,5mm rotatoria

Ti-Base HG 4,5mm antirrotatoria

Ti-Base HC 9mm rotatoria (recortable)

Ti-Base HC 9mm antirrotatoria (recortable)

**Tornillos se venden por separado*

SIS-2508RR

SIS-2508RA

SIS-2508RRG2

SIS-2508RAG2

SIS-2508RRG3

SIS-2508RAG3

SIS-2508RRG4

SIS-2508RAG4

SIS-2508RRC9

SIS-2508RAC9



Scanbody (Ti)

**Tornillos se venden por separado*

SIS-2590R



Sobrecolable Cr-Co rotatorio

Sobrecolable Cr-Co antirrotatorio

**Tornillos se venden por separado*

SIS-2530RR

SIS-2530RA



MEGAGEN ANYRIDGE®

Cónica Interna

		STD
	Pilar SIScator alt. 1mm	SIS-2510RH1
	Pilar SIScator alt. 2mm	SIS-2510RH2
	Pilar SIScator alt. 3mm	SIS-2510RH3
	Pilar SIScator alt. 4mm	SIS-2510RH4
	Pilar SIScator alt. 5mm	SIS-2510RH5
	Tornillo M1,8 (hex. 1,20)	SIS-2514R
	Tornillo extractor M1,8 (hex. 1,20)	SIS-2514RE
	TORNILLOS CON RECUBRIMIENTO BIOCARB	
	Tornillo M1,8 (hex. 1,20)	SIS-2514RB
	MULTI-UNIT SIS	
	Pilar Multi-Unit recto alt. 1,5mm	SIS-2560RH1C
	Pilar Multi-Unit recto alt. 2,5mm	SIS-2560RH2C
	Pilar Multi-Unit recto alt. 3,5mm	SIS-2560RH3C
	Pilar Multi-Unit recto alt. 4,5mm	SIS-2560RH4C
	Pilar Multi-Unit angul. 17° alt. 2,5mm	SIS-2570RH25
	Pilar Multi-Unit angul. 17° alt. 3,5mm	SIS-2570RH35
	Pilar Multi-Unit angul. 30° alt. 3,5mm	SIS-2571RH35
	Pilar Multi-Unit angul. 30° alt. 4,5mm	SIS-2571RH45
	Hexagonal 1,20	
	SMART ANGLE	
	Tornillo Smart Angle	SIS-2515R
	Tornillo Smart Angle alt. 3mm/4mm	SIS-2515RHG
	CHIMENEAS ANGULADAS PARA BASES DE Cr-Co	
	Chimenea ang. 17°	SIS-8222A
	Chimenea ang. 30°	SIS-8222B



DENTSPLY® XIVE®





Cónica Interna

		3.4	3.8
	Coping impresión (cubeta abierta) Hexagonal 0,90	SIS-2601N	SIS-2601R
	Análogo	SIS-2602N	SIS-2602R
	Tornillo fijación análogo digital Plana/Cruz	SIS-8888	SIS-8888
	Tapón cicatrización alt. 2mm	SIS-2604NH2	SIS-2604RH2
	Tapón cicatrización alt. 3mm	SIS-2604NH3	SIS-2604RH3
	Tapón cicatrización alt. 5mm Hexagonal 0,90	SIS-2604NH5	SIS-2604RH5
	Pilar recto antirrotatorio	SIS-2605NA	SIS-2605RA
	Pilar provisional rotatorio	SIS-2650NR	SIS-2650RR
	Pilar provisional antirrotatorio <i>*Tornillos se venden por separado</i>	SIS-2650NA	SIS-2650RA
	Ti-Base rotatoria	SIS-2608NR	SIS-2608RR
	Ti-Base antirrotatoria	SIS-2608NA	SIS-2608RA
	Ti-Base HC 9mm rotatoria (recortable)	SIS-2608NRC9	SIS-2608RRC9
	Ti-Base HC 9mm antirrotatoria (recortable) <i>*Tornillos se venden por separado</i>	SIS-2608NAC9	SIS-2608RAC9
	Scanbody (Ti) <i>*Tornillo se vende por separado</i>	SIS-2690N	SIS-2690R
	Sobrecolable Cr-Co rotatorio	SIS-2630NR	SIS-2630RR
	Sobrecolable Cr-Co antirrotatorio <i>*Tornillos se venden por separado</i>	SIS-2630NA	SIS-2630RA
	Pilar SISCator alt. 1mm	SIS-2610NH1	SIS-2610RH1
	Pilar SISCator alt. 2mm	SIS-2610NH2	SIS-2610RH2
	Pilar SISCator alt. 3mm	SIS-2610NH3	SIS-2610RH3
	Pilar SISCator alt. 4mm	SIS-2610NH4	SIS-2610RH4
	Pilar SISCator alt. 5mm	SIS-2610NH5	SIS-2610RH5
	Pilar SISCator alt. 6mm	SIS-2610NH6	SIS-2610RH6



DENTSPLY® XIVE®

Cónica Interna

		3.4	3.8
	Tornillo M1,6 (hex. 0,90)	SIS-2614N	SIS-2614R
	Tornillo M1,6 (hex. 1,20)	SIS-2614	SIS-2614
<hr/>			
	B TORNILLOS CON RECUBRIMIENTO BIOCARB		
	Tornillo M1,6 (hex. 0,90)	SIS-2614NB	SIS-2614RB
	Tornillo M1,6 (hex. 1,20)	SIS-2614B	SIS-2614B
<hr/>			
	SIS MULTI-UNIT SIS		
	Pilar Multi-Unit recto alt. 1,5mm	SIS-2660NH1C	SIS-2660RH1C
	Pilar Multi-Unit recto alt. 2,5mm	SIS-2660NH2C	SIS-2660RH2C
	Pilar Multi-Unit recto alt. 3,5mm	SIS-2660NH3C	SIS-2660RH3C
	Pilar Multi-Unit recto alt. 4,5mm	SIS-2660NH4C	SIS-2660RH4C
	Pilar Multi-Unit recto alt. 5,5mm	SIS-2660NH5C	SIS-2660RH5C
	Pilar Multi-Unit recto alt. 6,5mm	SIS-2660NH6C	SIS-2660RH6C
<hr/>			
	SMART ANGLE		
	Tornillo Smart Angle	SIS-2615N	SIS-2615R
	CHIMENEA CALCINABLE PARA BASES Cr-Co		
	Chimenea ang. 17°	SIS-8209A	SIS-8210A
	Chimenea ang. 30°	SIS-8209B	SIS-8210B



DENTSPLY® ANKYLOS®

Interna Ankylos

C
(Without Index)



Análogo
Tornillo fijación análogo digital
Ⓜ Plana/Cruz

SIS-2702N
SIS-8888



Tapón cicatrización alt. 2mm
Tapón cicatrización alt. 3mm
Tapón cicatrización alt. 4mm
Tapón cicatrización alt. 5mm
Ⓜ Hexagonal 1

SIS-2704NH2
SIS-2704NH3
SIS-2704NH4
SIS-2704NH5



Pilar provisional rotatorio
**Tornillos se venden por separado*

SIS-2750NR



Ti-Base rotatoria

SIS-2708NR



Ti-Base HC 9mm rotatoria (recortable)
**Tornillos se venden por separado*

SIS-2708NRC9



Scanbody rotatorio (Ti)
**Tornillos se venden por separado*

SIS-2790N



Sobrecolable Cr-Co rotatorio
**Tornillos se venden por separado*

SIS-2730NR



Pilar SIScator alt. 1mm
Pilar SIScator alt. 2mm
Pilar SIScator alt. 3mm
Pilar SIScator alt. 4mm
Pilar SIScator alt. 5mm
Pilar SIScator alt. 6mm



SIS-2710NH1
SIS-2710NH2
SIS-2710NH3
SIS-2710NH4
SIS-2710NH5
SIS-2710NH6

(*ADITAMENTOS SOLO BAJO PEDIDO)



DENTSPLY® ANKYLOS®

Interna Ankylos

		C (Without Index)
	Tornillo M1,8 (hex. 1)	SIS-2714
	TORNILLOS CON RECUBRIMIENTO BIOCARB Tornillo M1,8 (hex. 1)	SIS-2714B
	MULTIUNIT SIS	
	Pilar Multi-Unit recto alt. 1,5mm	SIS-2760NH1C
	Pilar Multi-Unit recto alt. 2,5mm	SIS-2760NH2C
	Pilar Multi-Unit recto alt. 3,5mm	SIS-2760NH3C
	Pilar Multi-Unit recto alt. 4,5mm	SIS-2760NH4C
	SMART ANGLE Tornillo Smart Angle	SIS-2715N
	CHIMENEAS ANGULADAS PARA BASES DE Cr-Co	
	Chimenea ang. 17°	SIS-8211A
	Chimenea ang. 30°	SIS-8211B



OSSTEM® TS/ HIOSSEN® ET

Cónica Interna



Coping impresión (cubeta abierta)

Hexagonal 1,25

MINI

SIS-2801N

REGULAR

SIS-2801R



Análogo

Tornillo fijación análogo digital

Plana/Cruz

SIS-2802N

SIS-8888

SIS-2802R

SIS-8888



Tapón cicatrización alt. 3mm

Tapón cicatrización alt. 4mm

Tapón cicatrización alt. 5mm

Tapón cicatrización alt. 7mm

Hexagonal 1,25

SIS-2804NH3

SIS-2804NH4

SIS-2804NH5

SIS-2804NH7

SIS-2804RH3

SIS-2804RH4

SIS-2804RH5

SIS-2804RH7



Pilar recto antirrotatorio

Pilar angulado 15°

Pilar angulado 25°

Pilar provisional rotatorio

Pilar provisional antirrotatorio

*Tornillos se venden por separado

SIS-2805NA

SIS-2882N

SIS-2883N

SIS-2850NR

SIS-2850NA

SIS-2805RA

SIS-2882R

SIS-2883R

SIS-2850RR

SIS-2850RA

SMART
TI-BASE



Ti-Base rotatoria

Ti-Base antirrotatoria

Ti-Base HG 2,5mm rotatoria

Ti-Base HG 2,5mm antirrotatoria

Ti-Base HG 3,5mm rotatoria

Ti-Base HG 3,5mm antirrotatoria

Ti-Base HG 4,5mm rotatoria

Ti-Base HG 4,5mm antirrotatoria

Ti-Base HC 7mm rotatoria

Ti-Base HC 7mm antirrotatoria

Ti-Base HG 2,5mm HC 7mm rotatoria

Ti-Base HG 2,5mm HC 7mm antirrotatoria

Ti-Base HG 3,5mm HC 7mm rotatoria

Ti-Base HG 3,5mm HC 7mm antirrotatoria

Ti-Base HG 4,5mm HC 7mm rotatoria

Ti-Base HG 4,5mm HC 7mm antirrotatoria

Ti-Base HC 9mm rotatoria (recortable)

Ti-Base HC 9mm antirrotatoria (recortable)

*Tornillos se venden por separado

SIS-2808NR

SIS-2808NA

SIS-2808NRG2

SIS-2808NAG2

SIS-2808NRG3

SIS-2808NAG3

SIS-2808NRG4

SIS-2808NAG4

SIS-2808NRC7

SIS-2808NAC7

SIS-2808NRG2C7

SIS-2808NAG2C7

SIS-2808NRG3C7

SIS-2808NAG3C7

SIS-2808NRG4C7

SIS-2808NAG4C7

SIS-2808NRC9

SIS-2808NAC9

SIS-2808RR

SIS-2808RA

SIS-2808RRG2

SIS-2808RAG2

SIS-2808RRG3

SIS-2808RAG3

SIS-2808RRG4

SIS-2808RAG4

SIS-2808RRC7

SIS-2808RAC7

SIS-2808RRG2C7

SIS-2808RAG2C7

SIS-2808RRG3C7

SIS-2808RAG3C7

SIS-2808RRG4C7

SIS-2808RAG4C7

SIS-2808RRC9

SIS-2808RAC9



Scanbody (Ti)

*Tornillos se venden por separado

SIS-2890N

SIS-2890R



Sobrecolable Cr-Co rotatorio

Sobrecolable Cr-Co antirrotatorio

*Tornillos se venden por separado

SIS-2830NR

SIS-2830NA

SIS-2830RR

SIS-2830RA



OSSTEM® TS/ HIOSSEN® ET

Cónica Interna

	MINI	REGULAR	
	Pilar SISCATOR alt. 1mm	SIS-2810NH1	SIS-2810RH1
	Pilar SISCATOR alt. 2mm	SIS-2810NH2	SIS-2810RH2
	Pilar SISCATOR alt. 3mm	SIS-2810NH3	SIS-2810RH3
	Pilar SISCATOR alt. 4mm	SIS-2810NH4	SIS-2810RH4
	Pilar SISCATOR alt. 5mm	SIS-2810NH5	SIS-2810RH5
	Pilar SISCATOR alt. 6mm	SIS-2810NH6	SIS-2810RH6
	Pilar SISCATOR angulado 15° alt. 1,5mm.		SIS-2817H1R
	Pilar SISCATOR angulado 15° alt. 3mm.		SIS-2817H3R
	Tornillo M1,6 (hex. 1,25)	SIS-2814N	
	Tornillo M2 (hex. 1,25)		SIS-2814R
	B TORNILLOS CON RECUBRIMIENTO BIOCARB		
	Tornillo M1,6 (hex. 1,25)	SIS-2814NB	
			SIS-2814RB
	SIS MULTI-UNIT SIS		
	Pilar Multi-Unit recto alt. 1,5mm	SIS-2860NH1C	SIS-2860RH1C
	Pilar Multi-Unit recto alt. 2,5mm	SIS-2860NH2C	SIS-2860RH2C
	Pilar Multi-Unit recto alt. 3,5mm	SIS-2860NH3C	SIS-2860RH3C
	Pilar Multi-Unit recto alt. 4,5mm	SIS-2860NH4C	SIS-2860RH4C
	Pilar Multi-Unit recto alt. 5,5mm	SIS-2860NH5C	SIS-2860RH5C
	Pilar Multi-Unit recto alt. 6,5mm	SIS-2860NH6C	SIS-2860RH6C
	mini MULTI-UNIT mini		
	Pilar Multi-Unit recto alt. 1,5mm	ARO-2880NH1	
	Pilar Multi-Unit recto alt. 2,5mm	ARO-2880NH2	
	Pilar Multi-Unit recto alt. 3,5mm	ARO-2880NH3	
	Pilar Multi-Unit recto alt. 4,5mm	ARO-2880NH4	
	Pilar Multi-Unit recto alt. 5,5mm	ARO-2880NH5	
	Pilar Multi-Unit recto alt. 6,5mm	ARO-2880NH6	
	Pilar Multi-Unit angul. 17° alt. 2,5mm	SIS-2870NH25	SIS-2870RH25
	Pilar Multi-Unit angul. 17° alt. 3,5mm	SIS-2870NH35	SIS-2870RH35
	Pilar Multi-Unit angul. 30° alt. 3,5mm	SIS-2871NH35	SIS-2871RH35
	Pilar Multi-Unit angul. 30° alt. 4,5mm	SIS-2871NH45	SIS-2871RH45
	H Hexagonal 1,20		
	SMART ANGLE		
	Tornillo Smart Angle	SIS-2815N	SIS-2815R
	Tornillo Smart Angle alt. 3mm/4mm	SIS-2815NHG	SIS-2815RHG
	CHIMENEA CALCINABLES BASES DE Cr-Co		
	Chimenea ang. 17°	SIS-8212A	SIS-8213A
	Chimenea ang. 30°	SIS-8212B	SIS-8213B

F: 2800

**DIO® UFII®**

Cónica Interna

REGULAR

Coping impresión (cubeta abierta)

Hexagonal 1,20

SIS-2901R



Análogo

Tornillo fijación análogo digital

Plana/Cruz

SIS-2902R

SIS-8888



Tapón cicatrización alt. 3mm

Tapón cicatrización alt. 4mm

Tapón cicatrización alt. 5mm

Tapón cicatrización alt. 7mm

Hexagonal 1.20

SIS-2904RH3

SIS-2904RH4

SIS-2904RH5

SIS-2904RH7



Pilar recto antirrotatorio

Pilar angulado 15°

Pilar angulado 25°

Pilar provisional rotatorio

Pilar provisional antirrotatorio

**Tornillos se venden por separado*

SIS-2905RA

SIS-2982R

SIS-2983R

SIS-2950RR

SIS-2950RA



Ti-Base rotatoria

Ti-Base antirrotatoria

SIS-2908RR

SIS-2908RA



Ti-Base HG 2,5mm rotatoria

Ti-Base HG 2,5mm antirrotatoria

Ti-Base HG 3,5mm rotatoria

Ti-Base HG 3,5mm antirrotatoria

Ti-Base HG 4,5mm rotatoria

Ti-Base HG 4,5mm antirrotatoria

SIS-2908RRG2

SIS-2908RAG2

SIS-2908RRG3

SIS-2908RAG3

SIS-2908RRG4

SIS-2908RAG4



Ti-Base HC 9mm rotatoria (recortable)

Ti-Base HC 9mm antirrotatoria (recortable)

**Tornillos se venden por separado*

SIS-2908RRC9

SIS-2908RAC9



Scanbody (Ti)

**Tornillos se venden por separado*

SIS-2990R





Sobrecolable Cr-Co rotatorio

Sobrecolable Cr-Co antirrotatorio

**Tornillos se venden por separado*

SIS-2930RR

SIS-2930RA

		REGULAR
	Pilar SIScator alt. 1mm	SIS-2910RH1
	Pilar SIScator alt. 2mm	SIS-2910RH2
	Pilar SIScator alt. 3mm	SIS-2910RH3
	Pilar SIScator alt. 4mm	SIS-2910RH4
	Pilar SIScator alt. 5mm	SIS-2910RH5
	Pilar SIScator alt. 6mm	SIS-2910RH6
	Pilar SIScator angulado 15° alt. 1,5mm.	SIS-2917H1R
	Pilar SIScator angulado 15° alt. 3mm.	SIS-2917H3R
	Tornillo M2 (hex. 1,20)	SIS-2914R
	 TORNILLOS CON RECUBRIMIENTO BIOCARB Tornillo M2 (hex. 1,20)	SIS-2914RB
	 MULTI-UNIT SIS Pilar Multi-Unit recto alt. 1,5mm	SIS-2960RH1C
	Pilar Multi-Unit recto alt. 2,5mm	SIS-2960RH2C
	Pilar Multi-Unit recto alt. 3,5mm	SIS-2960RH3C
	Pilar Multi-Unit recto alt. 4,5mm	SIS-2960RH4C
	Pilar Multi-Unit recto alt. 5,5mm	SIS-2960RH5C
	Pilar Multi-Unit recto alt. 6,5mm	SIS-2960RH6C
	Pilar Multi-Unit angul. 17° alt. 2,5mm	SIS-2870RH25
	Pilar Multi-Unit angul. 17° alt. 3,5mm	SIS-2870RH35
	Pilar Multi-Unit angul. 30° alt. 3,5mm	SIS-2871RH35
	Pilar Multi-Unit angul. 30° alt. 4,5mm	SIS-2871RH45
	 Hexagonal 1,20	
	SMART ANGLE Tornillo Smart Angle	SIS-2915R
	Tornillo Smart Angle alt. 3mm/4mm	SIS-2915RHG
	CHIMENEAS ANGULADAS PARA BASES DE Cr-Co Chimenea ang. 17°	SIS-8214A
	Chimenea ang. 30°	SIS-8214B



DENTIUM SUPERLINE™ & IMPLANTIUM®

Cónica Interna

STD



Coping impresión (cubeta abierta)

Hexagonal 1,27

SIS-3001R



Análogo

Tornillo fijación análogo digital

Plana/Cruz

SIS-3002R

SIS-8888



Tapón cicatrización alt. 3mm

Tapón cicatrización alt. 4mm

Tapón cicatrización alt. 5mm

Tapón cicatrización alt. 7mm

Hexagonal 1,27

SIS-3004RH3

SIS-3004RH4

SIS-3004RH5

SIS-3004RH7



Pilar recto antirrotatorio

Pilar angulado 15°

Pilar angulado 25°

Pilar provisional rotatorio

Pilar provisional antirrotatorio

SIS-3005RA

SIS-3082R

SIS-3083R

SIS-3050RR

SIS-3050RA

**Tornillos se venden por separado*

SMART
TI-BASE



Ti-Base rotatoria

Ti-Base antirrotatoria

SIS-3008RR

SIS-3008RA



Ti-Base HG 2,5mm rotatoria

Ti-Base HG 2,5mm antirrotatoria

Ti-Base HG 3,5mm rotatoria

Ti-Base HG 3,5mm antirrotatoria

Ti-Base HG 4,5mm rotatoria

Ti-Base HG 4,5mm antirrotatoria

SIS-3008RRG2

SIS-3008RAG2

SIS-3008RRG3

SIS-3008RAG3

SIS-3008RRG4

SIS-3008RAG4



Ti-Base HC 9mm rotatoria (recortable)

Ti-Base HC 9mm antirrotatoria (recortable)

SIS-3008RRC9

SIS-3008RAC9

**Tornillos se venden por separado*



Scanbody (Ti)

**Tornillos se venden por separado*

SIS-3090R



Sobrecolable Cr-Co rotatorio

Sobrecolable Cr-Co antirrotatorio

SIS-3030RR

SIS-3030RA

**Tornillos se venden por separado*



DENTIUM SUPERLINE™ & IMPLANTIUM®

Cónica Interna

		STD
	Pilar SIScator alt. 1mm	SIS-3010RH1
	Pilar SIScator alt. 2mm	SIS-3010RH2
	Pilar SIScator alt. 3mm	SIS-3010RH3
	Pilar SIScator alt. 4mm	SIS-3010RH4
	Pilar SIScator alt. 5mm	SIS-3010RH5
	Pilar SIScator alt. 6mm	SIS-3010RH6
	Pilar SIScator angulado 15° alt. 1,5mm.	SIS-3017H1R
	Pilar SIScator angulado 15° alt. 3mm.	SIS-3017H3R
	Tornillo M2 (hex. 1,27)	SIS-3014R
	B TORNILLOS CON RECUBRIMIENTO BIOCARB Tornillo M2 (hex. 1,27)	SIS-3014RB
SIS MULTI-UNIT SIS		
	Pilar Multi-Unit recto alt. 1,5mm	SIS-3060RH1C
	Pilar Multi-Unit recto alt. 2,5mm	SIS-3060RH2C
	Pilar Multi-Unit recto alt. 3,5mm	SIS-3060RH3C
	Pilar Multi-Unit recto alt. 4,5mm	SIS-3060RH4C
	Pilar Multi-Unit recto alt. 5,5mm	SIS-3060RH5C
	Pilar Multi-Unit recto alt. 6,5mm	SIS-3060RH6C
	Pilar Multi-Unit angul. 17° alt. 2,5mm	SIS-2870RH25
	Pilar Multi-Unit angul. 17° alt. 3,5mm	SIS-2870RH35
	Pilar Multi-Unit angul. 30° alt. 3,5mm	SIS-2871RH35
	Pilar Multi-Unit angul. 30° alt. 4,5mm	SIS-2871RH45
	Hexagonal 1,20	
	SMART ANGLE Tornillo Smart Angle	SIS-3015R
	Tornillo Smart Angle alt. 3mm/4mm	SIS-3015RHG
	CHIMENEAS ANGULADAS PARA BASES DE Cr-Co	
	Chimenea ang. 17°	SIS-8215A
	Chimenea ang. 30°	SIS-8215B

KLOCKNER® VEGA®
Hexágono Interno



Coping impresión (cubeta abierta)

Estrella

NV

SIS-3201N

RV

SIS-3201R



Análogo

Tornillo fijación análogo digital

Plana/Cruz

SIS-3202N

SIS-8888

SIS-3202R

SIS-8888



Tapón cicatrización alt. 2mm

Tapón cicatrización alt. 3mm

Tapón cicatrización alt. 4mm

Tapón cicatrización alt. 5mm

Tapón cicatrización alt. 6mm

Estrella

SIS-3204NH2

SIS-3204NH3

SIS-3204NH4

SIS-3204NH5

SIS-3204NH6

SIS-3204RH2

SIS-3204RH3

SIS-3204RH4

SIS-3204RH5

SIS-3204RH6



Pilar recto antirrotatorio

Pilar provisional rotatorio

Pilar provisional antirrotatorio

**Tornillos se venden por separado*

SIS-3205NA

SIS-3250NR

SIS-3250NA

SIS-3205RA

SIS-3250RR

SIS-3250RA

SMART
TI-BASE



Ti-Base rotatoria

Ti-Base antirrotatoria

SIS-3208NR

SIS-3208NA

SIS-3208RR

SIS-3208RA



Ti-Base HG 2,5mm rotatoria

Ti-Base HG 2,5mm antirrotatoria

Ti-Base HG 3,5mm rotatoria

Ti-Base HG 3,5mm antirrotatoria

Ti-Base HG 4,5mm rotatoria

Ti-Base HG 4,5mm antirrotatoria

SIS-3208NRG2

SIS-3208NAG2

SIS-3208NRG3

SIS-3208NAG3

SIS-3208NRG4

SIS-3208NAG4

SIS-3208RRG2

SIS-3208RAG2

SIS-3208RRG3

SIS-3208RAG3

SIS-3208RRG4

SIS-3208RAG4



Ti-Base HC 9mm rotatoria (recortable)

Ti-Base HC 9mm antirrotatoria (recortable)

**Tornillos se venden por separado*

SIS-3208NRC9

SIS-3208NAC9

SIS-3208RRC9

SIS-3208RAC9



Scanbody (Ti)

**Tornillos se venden por separado*

SIS-3290N

SIS-3290R



Sobrecolable Cr-Co rotatorio

Sobrecolable Cr-Co antirrotatorio

**Tornillos se venden por separado*

SIS-3230NR

SIS-3230NA

SIS-3230RR

SIS-3230RA



KLOCKNER® VEGA®

Hexágono Interno

		NV	RV
	Pilar SIScator alt. 2mm	SIS-3210NH2	SIS-3210RH2
	Pilar SIScator alt. 3mm	SIS-3210NH3	SIS-3210RH3
	Pilar SIScator alt. 4mm	SIS-3210NH4	SIS-3210RH4
	Pilar SIScator alt. 5mm	SIS-3210NH5	SIS-3210RH5
	Pilar SIScator alt. 6mm	SIS-3210NH6	SIS-3210RH6
	Tornillo M1,6 (estrella)	SIS-3214N	SIS-3214R
	Tornillo M1,8 (estrella)		
	B TORNILLOS CON RECUBRIMIENTO BIOCARB	SIS-3214NB	SIS-3214RB
	Tornillo M1,8 (estrella)		
	SIS MULTI-UNIT SIS		
	Pilar Multi-Unit recto alt. 1,5mm	SIS-3260NH1C	SIS-3260RH1C
	Pilar Multi-Unit recto alt. 2,5mm	SIS-3260NH2C	SIS-3260RH2C
	Pilar Multi-Unit recto alt. 3,5mm	SIS-3260NH3C	SIS-3260RH3C
	Pilar Multi-Unit recto alt. 4,5mm	SIS-3260NH4C	SIS-3260RH4C
	Pilar Multi-Unit recto alt. 5,5mm	SIS-3260NH5C	SIS-3260RH5C
	Pilar Multi-Unit recto alt. 6,5mm	SIS-3260NH6C	SIS-3260RH6C
	SMART ANGLE		
	Tornillo Smart Angle	SIS-3215N	SIS-3215R
	Tornillo Smart Angle alt. 3mm/4mm	SIS-3215NHG	SIS-3215RHG
	CHIMENEAS ANGULADAS PARA BASES DE Cr-Co		
	Chimenea ang. 17°	SIS-8207A	SIS-8207A
	Chimenea ang. 30°	SIS-8207B	SIS-8207B



ANTHOGYR® AXIOM® BL

RP



Coping impresión (cubeta abierta)

Hexagonal Axiom

SIS-3301R



Análogo

Tornillo fijación análogo digital

Plana/Cruz

SIS-3302R

SIS-8888



Pilar provisional rotatorio

Pilar provisional antirrotatorio

*Tornillos se venden por separado

SIS-3308RRC9

SIS-3308RAC9



Ti-Base rotatoria

Ti-Base antirrotatoria

SIS-3308RR

SIS-3308RA



Ti-Base HG 2,5mm rotatoria

Ti-Base HG 2,5mm antirrotatoria

SIS-3308RRHG2

SIS-3308RAHG2



Ti-Base HG 3,5mm rotatoria

Ti-Base HG 3,5mm antirrotatoria

SIS-3308RRHG3

SIS-3308RAHG3



Ti-Base HC 9mm rotatoria (recortable)

Ti-Base HC 9mm antirrotatoria (recortable)

*Tornillos se venden por separado

SIS-3308RRC9

SIS-3308RAC9



Scanbody (Ti)

*Tornillos se venden por separado

SIS-3390R



Pilar SIScator alt. 1mm

Pilar SIScator alt. 2mm

Pilar SIScator alt. 3mm

Pilar SIScator alt. 4mm

Pilar SIScator alt. 5mm

Pilar SIScator alt. 6mm

SIS-3310RH1

SIS-3310RH2

SIS-3310RH3

SIS-3310RH4

SIS-3310RH5

SIS-3310RH6



Tornillo M1,6 ESPECIAL (hex. Axiom)

Tornillo extractor M1,4 (hex. Axiom)



TORNILLOS CON RECUBRIMIENTO BIOCARB

Tornillo M1,6 ESPECIAL (hex. Axiom)

SIS-3314R

SIS-3314E

SIS-3314RB



MULTI-UNIT SIS



Pilar Multi-Unit recto alt. 1,5mm

Pilar Multi-Unit recto alt. 2,5mm

Pilar Multi-Unit recto alt. 3,5mm

Pilar Multi-Unit recto alt. 4,5mm

Pilar Multi-Unit recto alt. 5,5mm

Pilar Multi-Unit recto alt. 6,5mm

SIS-3360RH1C

SIS-3360RH2C

SIS-3360RH3C

SIS-3360RH4C

SIS-3360RH5C

SIS-3360RH6C



Pilar Multi-Unit angul. 17° alt. 2,5mm

Pilar Multi-Unit angul. 17° alt. 3,5mm

Pilar Multi-Unit angul. 30° alt. 3,5mm

Pilar Multi-Unit angul. 30° alt. 4,5mm

Hexagonal Axiom

SIS-3370RH2

SIS-3370RH3

SIS-3371RH3

SIS-3371RH4



SMART ANGLE

Tornillo Smart Angle

Tornillo Smart Angle alt. 3mm/4mm

SIS-3315R

SIS-3315RHG



BIOTECH DENTAL® KONTACT®

		RP
	Coping impresión (cubeta abierta) Hexagonal 1,20	SIS-3401R
	Análogo	SIS-3402R
	Tornillo fijación análogo digital Plana/Cruz	SIS-8888
	Pilar provisional rotatorio	SIS-3408RRC9
	Pilar provisional antirrotatorio <i>*Tornillos se venden por separado</i>	SIS-3408RAC9
	Ti-Base rotatoria	SIS-3408RR
	Ti-Base antirrotatoria	SIS-3408RA
	Ti-Base HG 2,5mm rotatoria	SIS-3408RRHG2
	Ti-Base HG 2,5mm antirrotatoria	SIS-3408RAHG2
	Ti-Base HG 3,5mm rotatoria	SIS-3408RRHG3
	Ti-Base HG 3,5mm antirrotatoria	SIS-3408RAHG3
	Ti-Base HC 9mm rotatoria (recortable)	SIS-3408RRC9
	Ti-Base HC 9mm antirrotatoria (recortable) <i>*Tornillos se venden por separado</i>	SIS-3408RAC9
	Scanbody (Ti) <i>*Tornillos se venden por separado</i>	SIS-3490R
	Pilar SIScator alt. 1mm	SIS-3410RH1
	Pilar SIScator alt. 2mm	SIS-3410RH2
	Pilar SIScator alt. 3mm	SIS-3410RH3
	Pilar SIScator alt. 4mm	SIS-3410RH4
	Pilar SIScator alt. 5mm	SIS-3410RH5
	Pilar SIScator alt. 6mm	SIS-3410RH6
	Tornillo M1,4 (hex. 1,20)	SIS-3414R
	Tornillo extractor M1,4 (hex. 1,20)	SIS-3414E
	TORNILLOS CON RECUBRIMIENTO BIOCARB	
	Tornillo M1,4 (hex. 1,20)	SIS-3414RB
	SIS MULTI-UNIT SIS Pilar Multi-Unit recto alt. 1,5mm	SIS-3460RH1C
	Pilar Multi-Unit recto alt. 2,5mm	SIS-3460RH2C
	Pilar Multi-Unit recto alt. 3,5mm	SIS-3460RH3C
	Pilar Multi-Unit recto alt. 4,5mm	SIS-3460RH4C
	Pilar Multi-Unit recto alt. 5,5mm	SIS-3460RH5C
	Pilar Multi-Unit recto alt. 6,5mm	SIS-3460RH6C
	Pilar Multi-Unit angul. 17° alt. 2,5mm	SIS-3470RH2
	Pilar Multi-Unit angul. 17° alt. 3,5mm	SIS-3470RH3
	Pilar Multi-Unit angul. 30° alt. 3,5mm	SIS-3471RH3
	Pilar Multi-Unit angul. 30° alt. 4,5mm Hexagonal 1,20	SIS-3471RH4
	SMART ANGLE	
	Tornillo Smart Angle	SIS-3415R
	Tornillo Smart Angle alt. 3mm/4mm	SIS-3415RHG



MEGAGEN ANYONE®

Cónica Interna

RP



Coping impresión (cubeta abierta)

SIS-3601R



Análogo

SIS-3602R

Tornillo fijación análogo digital

SIS-8888

Plana/Cruz



Tapón cicatrización alt. 3mm

SIS-3604RH3

Tapón cicatrización alt. 4mm

SIS-3604RH4

Tapón cicatrización alt. 5mm

SIS-3604RH5

Tapón cicatrización alt. 7mm

SIS-3604RH7

Hexagonal 1,20



Pilar recto antirrotatorio

SIS-3605RA

Pilar angulado 15°

SIS-3682R

Pilar angulado 25°

SIS-3683R

Pilar provisional rotatorio

SIS-3650RR

Pilar provisional antirrotatorio

SIS-3650RA

*Tornillos se venden por separado



Ti-Base rotatoria

SIS-3608RR

Ti-Base antirrotatoria

SIS-3608RA



Ti-Base HG 2,5mm rotatoria

SIS-3608RRG2

Ti-Base HG 2,5mm antirrotatoria

SIS-3608RAG2

Ti-Base HG 3,5mm rotatoria

SIS-3608RRG3

Ti-Base HG 3,5mm antirrotatoria

SIS-3608RAG3

Ti-Base HG 4,5mm rotatoria

SIS-3608RRG4

Ti-Base HG 4,5mm antirrotatoria

SIS-3608RAG4



Ti-Base HC 9mm rotatoria (recortable)

SIS-3608RRC9

Ti-Base HC 9mm antirrotatoria (recortable)

SIS-3608RAC9

*Tornillos se venden por separado



Scanbody (Ti)

SIS-3690R

*Tornillos se venden por separado



Sobrecolable Cr-Co rotatorio

SIS-3630RR

Sobrecolable Cr-Co antirrotatorio

SIS-3630RA





*Tornillos se venden por separado

(*ADITAMENTOS SOLO BAJO PEDIDO)



MEGAGEN ANYONE®

Cónica Interna

		RP
	Pilar SISCATOR alt. 1mm	SIS-3610RH1
	Pilar SISCATOR alt. 2mm	SIS-3610RH2
	Pilar SISCATOR alt. 3mm	SIS-3610RH3
	Pilar SISCATOR alt. 4mm	SIS-3610RH4
	Pilar SISCATOR alt. 5mm	SIS-3610RH5
	Pilar SISCATOR alt. 6mm	SIS-3610RH6
	Pilar SISCATOR angulado 15° alt. 1,5mm.	SIS-3617H1R
	Pilar SISCATOR angulado 15° alt. 3mm.	SIS-3617H3R
	Tornillo M2 (hex. 1,20)	SIS-3614R
	B TORNILLOS CON RECUBRIMIENTO BIOCARB Tornillo M2 (hex. 1,20)	SIS-3614RB
	SIS MULTI-UNIT SIS Pilar Multi-Unit recto alt. 1,5mm	SIS-3660RH1C
	Pilar Multi-Unit recto alt. 2,5mm	SIS-3660RH2C
	Pilar Multi-Unit recto alt. 3,5mm	SIS-3660RH3C
	Pilar Multi-Unit recto alt. 4,5mm	SIS-3660RH4C
	Pilar Multi-Unit recto alt. 5,5mm	SIS-3660RH5C
	Pilar Multi-Unit recto alt. 6,5mm	SIS-3660RH6C
	SMART ANGLE Tornillo Smart Angle	SIS-3615R
	Tornillo Smart Angle alt. 3mm/4mm	SIS-3615RHG
	CHIMENEAS ANGULADAS PARA BASES DE Cr-Co Chimenea ang. 17°	SIS-8215A
	Chimenea ang. 30°	SIS-8215B

F: 3600

KLOCKNER® SK2®
Hexágono Externo Alto

RP 4.2



Coping impresión (cubeta abierta)
Hexagonal 1,70

SIS-1005



Análogo
Tornillo fijación análogo digital
Plana/Cruz

SIS-1001

SIS-8888



Tapón cicatrización alt. 3,5mm
Tapón cicatrización alt. 4,5mm
Hexagonal 1,70

SIS-1010

SIS-1011



Pilar recto antirrotatorio
Pilar recto rotatorio
*Tornillos se venden por separado

SIS-1006

SIS-1007



Ti-Base rotatoria
Ti-Base antirrotatoria
*Tornillos se venden por separado

SIS-1008

SIS-1009



Scanbody (Ti)
*Tornillos se venden por separado

SIS-1090R



Calcinable rotatorio
Calcinable antirrotatorio
*Tornillos se venden por separado

SIS-1002

SIS-1003



Pilar SScator alt. 3mm
Pilar SScator alt. 4mm
Pilar SScator alt. 5mm
Pilar SScator alt. 6mm

SIS-1010RH3

SIS-1010RH4

SIS-1010RH5

SIS-1010RH6



Tornillo M1,8 (hex. 1,70)
Tornillo M1,8 (cruz)

SIS-1004

SIS-1004M



TORNILLOS CON RECUBRIMIENTO BIOCARB
Tornillo M1,8 (hex. 1,70)

SIS-1004B



INSTRUMENTOS PARA IMPLANTOLOGÍA

THINK DIGITAL

SMART IMPLANT SOLUTIONS OFRECE UNA AMPLIA GAMA DE ACCESORIOS:

- Kits que se componen de mango corto (clínica) o largo (laboratorio) y diferentes puntas a elegir.
- Llaves especiales para Locator®/SIScator, Multi-Unit, carracas, mangos, adaptadores, etc.
- Puntas para destornilladores de múltiples cabezas en tamaño corto (20mm), mediano (25mm) o largo (35mm).



Kit destornillador mango corto (clínica)
Consta de 6 puntas e incluye el mango corto.

SIS-9114S

Kit destornillador mango largo (laboratorio)
Consta de 6 puntas e incluye el mango largo.

SIS-9115S

Kit de carraca dinamométrica
Consta de carraca dinamométrica, 6 puntas e incluye el mango corto.

SIS-9116S

Mangos, carracas y adaptadores



Carraca dinamométrica

SIS-9118



Llave manual carraca

SIS-9139



Mango corto (clínica)

SIS-9101A



Mango largo (laboratorio)

SIS-9102



Adaptador carraca conexión contra-ángulo

SIS-9139A

Punta destornillador Smart Angle

CORTA 20mm

MEDIANA 25mm

LARGA 35mm



















SIS-9142C

SIS-9142M

SIS-9142L

Llave carraca SIScator 	SIS-9113	Llave contraángulo SIScator 	SIS-9134
Llave SIScator Core Tool 	SIS-9146	Llave transportadora Multi-Unit mini 	ARO-9136N
Llave carraca Multi-Unit larga (hex. 2) 	SIS-9135	Llave contra-ángulo Multi-Unit (hex. 2) 	SIS-9136
Llave manual carraca 	SIS-9139	Mango corto clínica 	SIS-9101A

PUNTAS PARA DESTORNILLADOR

		CORTA 20mm	MEDIANA 25mm	LARGA 35mm	
	Punta hexagonal 0,90	SIS-9131	SIS-9132		Nobel Biocare® Astra®
	Punta hexagonal 1,00		SIS-9147M		
	Punta hexagonal 1,20	SIS-9103C	SIS-9103	SIS-9123	
	Punta hexagonal 1,25	SIS-9104C	SIS-9104	SIS-9124	
	Punta hexagonal 1,27	SIS-9105C	SIS-9105	SIS-9125	
	Punta hexagonal 1,70	SIS-9120C	SIS-9120	SIS-9126	
	Punta plana 0,5	SIS-9121C	SIS-9121	SIS-9127	Sistemas de tipo ranurado
	Punta torx	SIS-9106C	SIS-9106	SIS-9130	Straumann®
	Punta cuadrada 1,25	SIS-9133C	SIS-9133M	SIS-9133L	Nobel Biocare®
	Punta cuadrada 1,30	SIS-9137C	SIS-9137M	SIS-9137L	Nobel Biocare®
	Punta cruz tipo kl	SIS-9122C	SIS-9122	SIS-9128	Klockner®
	Punta cruz tipo ek	SIS-9138C	SIS-9138M	SIS-9138L	Eckermann®
	Punta unigrip	SIS-9112	SIS-9111	SIS-9129	Nobel Biocare®
	Punta estrella (Neo)	SIS-9143C	SIS-9143M	SIS-9143L	Neodent GM®
	Punta estrella	SIS-9144C	SIS-9144M	SIS-9144L	Klockner® Vega®
	Punta hexagonal Axiom		SIS-9145M		Anthogyr® Axiom® BL

EXTRACTORES DE IMPLANTES Y TORNILLOS

USOS ESPECÍFICOS DE LOS TIPOS DE EXTRACTORES.



EXTRACTOR PARA TORNILLOS CORONADOS O DEFORMADOS:

EXTRACTOR TIPO 1

- Diseñado para extraer tornillos con la conexión coronada o deformada.
- Universal para hexagonales de 1,20 / 1,25 / 1,27 / 1,30, unigrip, Torx, etc.
- Indicado para tornillos, pilares de cicatrización, etc.

EXTRACTOR TIPO 2

- Diseñado para extraer tornillos con la conexión totalmente deteriorada.
- Se utiliza cuando el extractor tipo 1 no sujeta o arrastra la zona afectada.

TORNILLO CORONADO: Tornillo que mantiene la cabeza del mismo pero la conexión para la llave está deteriorada parcial o totalmente.

EXTRACTOR PARA IMPLANTES FRACASADOS:

EXTRACTOR TIPO 3

- Diseñado para extraer implantes fracasados con rosca M1,6.
- Universal para la mayoría de implantes del mercado. No debe exceder un torque superior a 100 N cm.
- Para torques mayores debe utilizarse el extractor tipo 4.

EXTRACTOR TIPO 4

- Diseñado para extraer implantes fracasados con rosca M1,8 y M2. Universal para la mayoría de implantes del mercado.
- Aconsejable no exceder un torque superior a 200 N cm.
- También puede ser utilizado para implantes de rosca M1,6 si previamente se ha utilizado el extractor tipo 3.

IMPLANTE FRACASADO: Es el implante que por causas como infección, poco hueso, mala higiene, prótesis incorrecta, etc... no alcanza una correcta osteointegración y tiene un movimiento anormal. Su extracción será con muy poco torque, nunca superior a las indicaciones técnicas del extractor, de forma fácil y cómoda.

INSTRUCCIONES DE USO



DESTORNILLADOR

ELÉCTRICO SMART



- Cargador para puerto USB.
- Soporte imantado para puntas.
- Construido en aleación de aluminio ultraligero.
- 8 niveles de torque, desde 1 a 25 Newton.



VIDEO

Funcionamiento
destornillador
eléctrico Smart.

REF. SIS-9102E

PUNTAS SMART



- Puntas fabricadas en acero INOX AISI-420F, templado y revenido.
- Marcado láser para rápida identificación de la conexión.
- Punta imantada, favorece el rápido intercambio.

Hexagonal 1,20	Nobel Biocare® Astra®	SIS-9103E
Hexagonal 1,25		SIS-9104E
Hexagonal 1,27		SIS-9105E
Torx	Straumann®	SIS-9106E
Cruz	Klockner® Eckermann®	SIS-9122E
Unigrip (estrella)	Nobel Biocare®	SIS-9111E
Smart Angle	Solución angulada	SIS-9142E

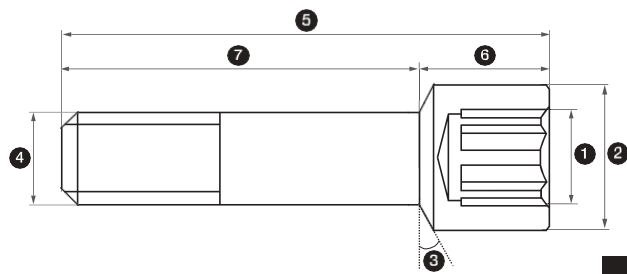

ESPECIFICACIONES TÉCNICAS DE TORNILLOS

REFERENCIA	COMPATIBILIDAD	PLATAFORMA	LLAVE	1	2	3	4	5	6	7
				DIÁMETR O CABEZA (mm)	ASIENTO	MÉTRICA	LONGITU D TOTAL (mm)	LONGITU D CABEZA (mm)	LONGITU D CUERPO (mm)	
SIS-3314R	Anthogyr® Axiom® BL	Ø RP	Hex. Axiom	2,2	20°	M 1,6 ESPECIAL	8	1,35	6,65	
SIS-0514X	Astra® Tech Osseospeed®	Ø 3,0	Hex. 1,27	2,2	30°	M 1,4	7,5	1,77	5,73	
SIS-0515X	Astra® Tech Osseospeed®	Ø 3,0	Smart Angle	2,3	30°	M 1,4	7,5	1,77	5,73	
SIS-0515XHG	Astra® Tech Osseospeed®	Ø 3,0	Smart Angle	2,3	30°	M 1,4	10,55	4,9	5,65	
SIS-0540	Astra® Tech Osseospeed®	Ø 3,5/4,0	Hex. 1,27	2,35	0°	M 1,6	8,25	2	6,25	
SIS-0541	Astra® Tech Osseospeed®	Ø 4,5/5,0	Hex. 1,27	2,35	0°	M 2	10,3	2	8,3	
SIS-2018	Astra® Tech Osseospeed®	Ø 3,5/4,0	Smart Angle	2,3	0°	M 1,6	7,6	1,5	6,1	
SIS-2018HG	Astra® Tech Osseospeed®	Ø 3,5/4,0	Smart Angle	2,3	0°	M 1,6	11	4,9	6,1	
SIS-2019	Astra® Tech Osseospeed®	Ø 4,5/5,0	Smart Angle	2,3	0°	M 2	9	1,5	7,5	
SIS-2019HG	Astra® Tech Osseospeed®	Ø 4,5/5,0	Smart Angle	2,3	0°	M 2	13,15	5,65	7,5	
SIS-2314L	Astra® Tech System™ Evolution	Ø 4,8	Hex. 1,27	2,35	0°	M 2	7,6	1,6	6	
SIS-2314R	Astra® Tech System™ Evolution	Ø 3,6	Hex. 1,27	2,13	60°	M 1,6	7,45	1,65	5,8	
SIS-2314W	Astra® Tech System™ Evolution	Ø 4,2	Hex. 1,27	2,35	40°	M 1,8	7,6	1,37	6,23	
SIS-2314X	Astra® Tech System™ Evolution	Ø 3,0	Hex. 1,27	2,15	65°	M 1,4	7,65	1,59	6,06	
SIS-2315L	Astra® Tech System™ Evolution	Ø 4,8	Smart Angle	2,4	0°	M 2	7,5	1,5	6	
SIS-2315LHG	Astra® Tech System™ Evolution	Ø 4,8	Smart Angle	2,4	0°	M 2	12,2	5,5	6,7	
SIS-2315R	Astra® Tech System™ Evolution	Ø 3,6	Smart Angle	2,3	60°	M 1,6	7,45	1,65	5,8	
SIS-2315RHG	Astra® Tech System™ Evolution	Ø 3,6	Smart Angle	2,3	60°	M 1,6	11,25	5,4	5,85	
SIS-2315W	Astra® Tech System™ Evolution	Ø 4,2	Smart Angle	2,3	40°	M 1,8	7,6	1,45	6,15	
SIS-2315WHG	Astra® Tech System™ Evolution	Ø 4,2	Smart Angle	2,3	40°	M 1,8	11,65	5,65	6	
SIS-2315X	Astra® Tech System™ Evolution	Ø 3,0	Smart Angle	2,3	65°	M 1,4	7,4	1,41	5,99	
SIS-2315XHG	Astra® Tech System™ Evolution	Ø 3,0	Smart Angle	2,3	65°	M 1,4	11	5	6	
SIS-2001HG	Biomet 3i® Osseotite®	Ø RP 4,1	Smart Angle	2,3	45°	M 2	7,5	3	4,5	
SIS-1614N	Biohorizons® Tapered®	Ø 3,0/ Ø 3,5/ Ø 4,5	Hex. 1,27	2,4	45°	UNF 1/72	7,2	1,87	5,33	
SIS-1615N	Biohorizons® Tapered®	Ø 3,0/ Ø 3,5/ Ø 4,5	Smart Angle	2,3	45°	UNF 1/72	7,1	1,82	5,28	
SIS-1615NHG	Biohorizons® Tapered®	Ø 3,0/ Ø 3,5/ Ø 4,5	Smart Angle	2,3	45°	UNF 1/72	10,1	4,8	5,3	
SIS-0452	Biomet 3i® Certain®	Ø 3,4 / Ø 4,1/ Ø 5,0	Hex. 1,20	2,02	0°	M 1,6	8,4	1,9	6,5	
SIS-0455	Biomet 3i® Certain®	Ø 4,1/ Ø 5,0	Hex. 1,20	2,29	45°	M 1,6	8,4	1,8	6,6	
SIS-2006	Biomet 3i® Certain®	Ø 3,4 / Ø 4,1/ Ø 5,0	Smart Angle	2,3	90°	M 1,6	8,4	1,6	6,8	
SIS-2006HG	Biomet 3i® Certain®	Ø 3,4 / Ø 4,1	Smart Angle	2,3	90°	M 1,6	11,8	5	6,8	
SIS-0151	Biomet 3i® Osseotite®	Ø 3,4/ Ø 4,1/ Ø 5,0	Unigrip	2,4	45°	M 2	7,9	1,85	6,05	
SIS-0152	Biomet 3i® Osseotite®	Ø 3,4/ Ø 4,1/ Ø 5,0	Hex. 1,20	2,4	45°	M 2	7,9	1,65	6,25	
SIS-0153	Biomet 3i® Osseotite®	Ø 3,4/ Ø 4,1/ Ø 5,0	Hex. 1,25	2,4	45°	M 2	7,9	1,65	6,25	
SIS-0154	Biomet 3i® Osseotite®	Ø 3,4/ Ø 4,1/ Ø 5,0	Cuadrado 1,30	2,4	45°	M 2	7,9	1,85	6,05	
SIS-0160	Biomet 3i® Osseotite®	Ø 3,4/ Ø 4,1/ Ø 5,0	Hex. 1,20	2,45	45°	M 2	7,9	1,85	6,05	
SIS-0161	Biomet 3i® Osseotite®	Ø 3,4/ Ø 4,1/ Ø 5,0	Hex. 1,25	2,45	45°	M 2	7,9	1,85	6,05	
SIS-2028	Biomet 3i® Osseotite®	Ø 3,4/ Ø 4,1/ Ø 5,0	Smart Angle	2,3	45°	M 2	6	1,5	4,5	
SIS-3414R	Biotech Dental® Kontakt®	Ø RP	Hex. 1,20	1,92	45°	M 1,4	7,7	1,4	6,3	
SIS-3415R	Biotech Dental® Kontakt®	Ø RP	Smart Angle	2,3	45°	M 1,4	7,85	1,4	6,45	
SIS-3415RHG	Biotech Dental® Kontakt®	Ø RP	Smart Angle	2,3	45°	M 1,4	12,1	5,65	6,45	
SIS-0151	Bti®	Ø 4,1	Unigrip	2,4	45°	M 2	7,9	1,85	6,05	
SIS-0152	Bti®	Ø 4,1	Hex. 1,20	2,4	45°	M 2	7,9	1,65	6,25	
SIS-0153	Bti®	Ø 4,1	Hex. 1,25	2,4	45°	M 2	7,9	1,65	6,25	
SIS-0154	Bti®	Ø 4,1	Cuadrado 1,30	2,4	45°	M 2	7,9	1,85	6,05	
SIS-0160	Bti®	Ø 4,1	Hex. 1,20	2,45	45°	M 2	7,9	1,85	6,05	
SIS-0161	Bti®	Ø 4,1	Hex. 1,25	2,45	45°	M 2	7,9	1,85	6,05	
SIS-1210	Bti®	Ø 3,5	Hex. 1,20	2,55	0°	M 2	5,5	1,7	3,8	
SIS-2001	Bti®	Ø 4,1	Smart Angle	2,3	45°	M 2	6	1,5	4,5	
SIS-2001HG	Bti®	Ø 4,1	Smart Angle	2,3	45°	M 2	7,5	3	4,5	
SIS-2026	Bti®	Ø 3,5	Smart Angle	2,35	0°	M 2	5,5	1,7	3,8	
SIS-2023	BTI® CORE	Ø 3,3/4,75	Smart Angle	2,3	0°	M 1,8	6,5	1,5	5	
SIS-2023HG	BTI® CORE	Ø 3,3/4,75	Smart Angle	2,3	0°	M 1,8	9,8	4,8	5	
SIS-3514N	BTI® CORE	Ø 3,3/4,75	Hex. 1,20	2,5	0°	M 1,8	7	2	5	
SIS-0710	Bti® Interno	Ø 4,1/5,5	Hex. 1,20	2,5	0°	M 1,8	7	2	5	

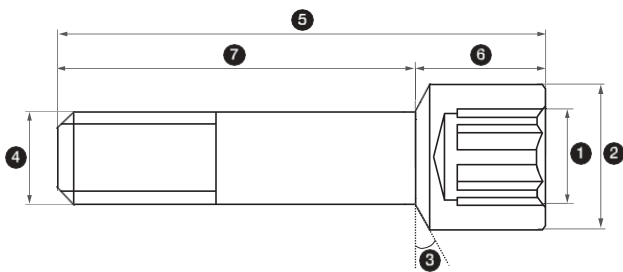

**EL TORQUE DE APRIETE SIEMPRE
DEBERÁ SER EL INDICADO POR EL
FABRICANTE DEL IMPLANTE.**



Más información en:
INSTRUCCIONES DE USO.PDF >>>

REFERENCIA	COMPATIBILIDAD	PLATAFORMA	LLAVE	DIÁMETRO O CABEZA (mm)	3 ASIENTO	4 MÉTRICA	5 LONGITU D TOTAL (mm)	6 LONGITU D CABEZA (mm)	7 LONGITU D CUERPO (mm)
SIS-0710N	Bti® Interno	Ø 3,5	Hex. 1,20	2,5	0°	M 1,8	7	2	5
SIS-0710Q	Bti® Interno	Ø 4,1/5,5	Cuadrado 1,30	2,5	0°	M 1,8	7	2	5
SIS-2023	Bti® Interno	Ø 3,5/4,1/5,5	Smart Angle	2,3	0°	M 1,8	7	2	5
SIS-2023HG	Bti® Interno	Ø 3,5/4,1	Smart Angle	2,3	0°	M 1,8	9,8	4,8	5
SIS-2714	Denstply® Ankylos®	Ø C (Without Index)	Hex. 1,0	2,2	30°	M1,8	8,15	1,35	6,8
SIS-2715N	Denstply® Ankylos®	Ø C (Without Index)	Smart Angle	2,35	60°	M 1,8	9,01	1,8	7,21
SIS-2614	Denstply® Xive®	Ø3,4/Ø3,8	Hex. 1,20	2,06	45°	M 1,6	8,5	1,4	7,1
SIS-2614N	Denstply® Xive®	Ø3,4	Hex. 0,90	2,06	45°	M 1,6	8,5	1,4	7,1
SIS-2614R	Denstply® Xive®	Ø 3,8	Hex. 0,90	2,06	45°	M 1,6	8,5	1,4	7,1
SIS-2615N	Denstply® Xive®	Ø3,4	Smart Angle	2,3	45°	M 1,6	8,9	1,67	7,23
SIS-2615R	Denstply® Xive®	Ø 3,8	Smart Angle	2,3	45°	M 1,6	8,9	1,67	7,23
SIS-3014R	Dentium Superline™ & Implantium®	Ø STD	Hex. 1,27	2,29	30°	M 2	10,2	1,9	8,3
SIS-3015R	Dentium Superline™ & Implantium®	Ø STD	Smart Angle	2,3	30°	M 2	10,2	1,9	8,3
SIS-3015RHG	Dentium Superline™ & Implantium®	Ø STD	Smart Angle	2,3	30°	M 2	11,65	3,35	8,3
SIS-2914R	Dio® Ufil®	Ø REGULAR	Hex. 1,20	2,45	30°	M 2	8,5	1,7	6,8
SIS-2915R	Dio® Ufil®	Ø REGULAR	Smart Angle	2,3	30°	M 2	8,5	1,7	6,8
SIS-2915RHG	Dio® Ufil®	Ø REGULAR	Smart Angle	2,3	30°	M 2	11,3	4,8	6,5
SIS-1004	Klockner® Sk2®	Ø 4,2	Hex 1,70	2,45	45°	M 1,8	6	2,07	3,93
SIS-1004M	Klockner® Sk2®	Ø 4,2	Cruz	2,45	45°	M 1,8	4,32	0,43	3,89
SIS-3214N	Klockner® Vega®	Ø NV	Estrella	2,15	90°	M 1,6	8	2	6
SIS-3214R	Klockner® Vega®	Ø RV	Estrella	2,15	90°	M 1,8	8	2	6
SIS-3215N	Klockner® Vega®	Ø NV	Smart Angle	2,3	45°	M 1,6	7,78	1,7	6,08
SIS-3215NHG	Klockner® Vega®	Ø NV	Smart Angle	2,3	45°	M 1,6	11,75	5,75	6
SIS-3215R	Klockner® Vega®	Ø RV	Smart Angle	2,3	45°	M 1,8	7,78	1,7	6,08
SIS-3215RHG	Klockner® Vega®	Ø RV	Smart Angle	2,3	45°	M 1,8	11,6	5,4	6,2
SIS-3615R	Megagen Anyone®	Ø RP	Smart Angle	2,3	30°	M 2	10,2	1,9	8,3
SIS-3615RHG	Megagen Anyone®	Ø RP	Smart Angle	2,3	30°	M 2	11,65	3,35	8,3
SIS-2514R	Megagen Anyridge®	Ø STD	Hex. 1,20	2,1	0°	M 1,8	8	2	6
SIS-2515R	Megagen Anyridge®	Ø STD	Smart Angle	2,3	0°	M 1,8	8	2	6
SIS-2515RHG	Megagen Anyridge®	Ø STD	Smart Angle	2,3	0°	M 1,8	10,9	4,8	6,1
SIS-0351M	Mis® C1/V3	Ø SP	Hex. 1,27	2,2	30°	UNF 1/72	7,5	2,3	5,2
SIS-2007M	Mis® C1/V3	Ø SP	Smart Angle	2,3	30°	UNF 1/72	7,1	1,45	5,65
SIS-2007MHG	Mis® C1/V3	Ø SP	Smart Angle	2,3	30°	UNF 1/72	10,2	4,55	5,65
SIS-0351M	Mis® C1/V3®	Ø 3,3	Hex. 1,27	2,1	30°	M 1,6	7,6	1,85	5,75
SIS-0351M	Mis® Seven®	Ø 3,75/4,20 - Ø 5,0/6,0	Hex. 1,27	2,2	30°	UNF 1/72	7,5	2,3	5,2
SIS-0351MX	Mis® Seven®	Ø 3,3	Hex. 1,27	2,1	30°	M 1,6	7,6	1,85	5,75
SIS-2007M	Mis® Seven®	Ø 3,75/4,20 - Ø 5,0/6,0	Smart Angle	2,3	30°	UNF 1/72	7,1	1,45	5,65
SIS-2007MHG	Mis® Seven®	Ø 3,75/4,20	Smart Angle	2,3	30°	UNF 1/72	10,2	4,55	5,65
SIS-2025	Mis® Seven®	Ø 3,3	Smart Angle	2,3	30°	M 1,6	7,1	1,57	5,53
SIS-2025HG	Mis® Seven®	Ø 3,3	Smart Angle	2,3	30°	M 1,6	9,9	4,4	5,5
SIS-1307	MultiUnit SIS®	Ø RP	Unigrip	2	45°	M 1,4	3,5	1,3	2,2
SIS-1307A	MultiUnit SIS®	Ø RP	Hex. 1,27	2	0°	M 1,4	3,5	1,3	2,2
SIS-1307H	MultiUnit SIS®	Ø RP	Hex. 1,20	2,2	0°	M 1,4	3,5	1,4	2,1
SIS-2012	MultiUnit SIS®	Ø RP	Smart Angle	2,4	0°	M 1,4	3,9	1,8	2,1
SIS-2214R	Neobiotech® is system	Ø REGULAR	Hex. 1,20	2,3	30°	M 2	8,8	1,65	7,15
SIS-2215R	Neobiotech® is system	Ø REGULAR	Smart Angle	2,3	30°	M 2	7,9	1,4	6,5
SIS-2215RHG	Neobiotech® is system	Ø REGULAR	Smart Angle	2,3	30°	M 2	11,45	4,95	6,5
SIS-2414R	Neodent GM® (Helix GM®, Drive GM®, Titamax GM®)	Ø STD	Neo	1,88	60°	M 1,6	9,7	1,45	8,25
SIS-2415R	Neodent GM® (Helix GM®, Drive GM®, Titamax GM®)	Ø STD	Smart Angle	2,3	60°	M 1,6	10,31	1,7	8,61
SIS-2415RHG	Neodent GM® (Helix GM®, Drive GM®, Titamax GM®)	Ø STD	Smart Angle	2,3	60°	M 1,6	12,2	3,6	8,6
SIS-0151	Nobel Biocare® Branemark®	Ø 3,75/Ø 4,0	Unigrip	2,4	45°	M 2	7,9	1,85	6,05
SIS-0152	Nobel Biocare® Branemark®	Ø 3,75/Ø 4,0	Hex. 1,20	2,4	45°	M 2	7,9	1,65	6,25
SIS-0153	Nobel Biocare® Branemark®	Ø 3,75/Ø 4,0	Hex. 1,25	2,4	45°	M 2	7,9	1,65	6,25
SIS-0154	Nobel Biocare® Branemark®	Ø 3,75/Ø 4,0	Cuadrado 1,30	2,4	45°	M 2	7,9	1,85	6,05

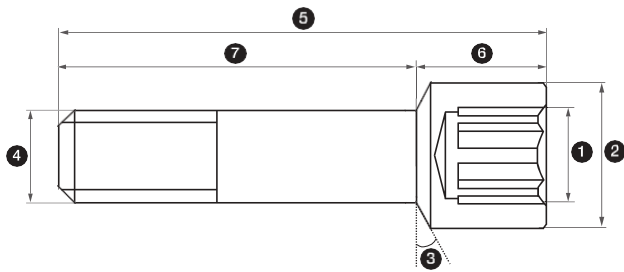

EL TORQUE DE APRIETE SIEMPRE DEBERÁ SER EL INDICADO POR EL FABRICANTE DEL IMPLANTE.



Más información en:
INSTRUCCIONES DE USO.PDF >>>

REFERENCIA	COMPATIBILIDAD	PLATAFORMA	LLAVE	DÁMETRO CABEZA (mm)	ASIENTO	MÉTRICA	LONGTUD TOTAL (mm)	LONGTUD CABEZA (mm)	LONGTUD CUERPO (mm)
SIS-0156	Nobel Biocare® Branemark®	Ø 5,0	Hex. 1,20	3,3	45°	M 2,5	7,02	1,4	
SIS-0160	Nobel Biocare® Branemark®	Ø 3,75/Ø 4,0	Hex. 1,20	2,45	45°	M 2	7,9	1,85	6,05
SIS-0161	Nobel Biocare® Branemark®	Ø 3,75/Ø 4,0	Hex. 1,25	2,45	45°	M 2	7,9	1,85	
SIS-0915	Nobel Biocare® Branemark®	Ø 3,3	Unigrip	2,2	55°	M 1,6	7,3	1,4	5,9
SIS-2001	Nobel Biocare® Branemark®	Ø 3,75/Ø 4,0	Smart Angle	2,3	45°	M 2	6	1,5	
SIS-2001HG	Nobel Biocare® Branemark®	"Ø 3,75/Ø 4,0	Smart Angle	2,3	45°	M 2	7,5	3	4,5
SIS-2002	Nobel Biocare® Branemark®	Ø 3,3	Smart Angle	2,3	55°	M 1,6	7,67	1,7	
SIS-2002HG	Nobel Biocare® Branemark®	Ø 3,3	Smart Angle	2,3	55°	M 1,6	7,9	3,5	4,4
SIS-0914	Nobel Biocare® NobelActive®	Ø 4,3/5,0	Unigrip	2,52	55°	M 2	7,33	1,2	
SIS-0915	Nobel Biocare® NobelActive®	Ø 3,5/3,75	Unigrip	2,2	55°	M 1,6	7,3	1,4	5,9
SIS-2003	Nobel Biocare® NobelActive®	Ø 4,3/5,0	Smart Angle	2,3	55°	M 2	7,5	1,4	
SIS-2003HG	Nobel Biocare® NobelActive®	Ø 4,3/5,0	Smart Angle	2,3	55°	M 2	11,7	5,6	6,1
SIS-2017	Nobel Biocare® NobelActive®	Ø 3,5/3,75	Smart Angle	2,3	55°	M 1,6	7,3	1,74	
SIS-2017HG	Nobel Biocare® NobelActive®	Ø 3,5/3,75	Smart Angle	2,3	55°	M 1,6	11,5	5,95	5,55
SIS-0852	Nobel Biocare® Replace Select®	Ø 3,5	Unigrip	2,4	0°	M 1,8	8,3	1,8	
SIS-0853	Nobel Biocare® Replace Select®	Ø 4,3/5,0	Unigrip	2,4	0°	M 2	9,9	1,5	8,4
SIS-2004	Nobel Biocare® Replace Select®	Ø 4,3/5,0	Smart Angle	2,3	0°	M2	9	1,5	
SIS-2005	Nobel Biocare® Replace Select®	Ø 3,5	Smart Angle	2,3	0°	M 1,8	7,5	1,38	6,12
SIS-2814N	Osstem® Ts/Hiossen® Et	Ø MINI	Hex. 1,25	2,22	45°	M 1,6	10,2	2,08	
SIS-2814R	Osstem® Ts/Hiossen® Et	Ø REGULAR	Hex. 1,25	2,33	45°	M 2	8,35	2,05	6,3
SIS-2815N	Osstem® Ts/Hiossen® Et	Ø MINI	Smart Angle	2,3	45°	M 1,6	9,4	1,4	8
SIS-2815NHG	Osstem® Ts/Hiossen® Et	Ø MINI	Smart Angle	2,3	45°	M 1,6	13,2	5,2	8
SIS-2815R	Osstem® Ts/Hiossen® Et	Ø REGULAR	Smart Angle	2,3	45°	M 2	7,9	1,4	
SIS-2815RHG	Osstem® Ts/Hiossen® Et	Ø REGULAR	Smart Angle	2,3	45°	M 2	11	4,5	6,5
SIS-0151	Phibo® Tsh®	Ø 4,0 / Ø 5,0	Unigrip	2,4	45°	M 2	7,9	1,85	
SIS-0152	Phibo® Tsh®	Ø 4,0 / Ø 5,0	Hex. 1,20	2,4	45°	M 2	7,9	1,65	6,25
SIS-0153	Phibo® Tsh®	Ø 4,0 / Ø 5,0	Hex. 1,25	2,4	45°	M 2	7,9	1,65	
SIS-0154	Phibo® Tsh®	Ø 4,0 / Ø 5,0	Cuadrado 1,30	2,4	45°	M 2	7,9	1,85	6,05
SIS-0160	Phibo® Tsh®	Ø 4,0 / Ø 5,0	Hex. 1,20	2,45	45°	M 2	7,9	1,85	
SIS-0161	Phibo® Tsh®	Ø 4,0 / Ø 5,0	Hex. 1,25	2,45	45°	M 2	7,9	1,85	6,05
SIS-1505	Phibo® Tsh®	Ø 3,3	Hex. 1,25	2,25	30°	M 1,8	8	1,8	
SIS-2001HG	Phibo® Tsh®	Ø 4,0	Smart Angle	2,3	45°	M 2	7,5	3	4,5
SIS-2024	Phibo® Tsh®	Ø 3,3	Smart Angle	2,35	30°	M 1,8	7,9	1,7	
SIS-2027	Phibo® Tsh®	Ø 4,0 / Ø 5,0	Smart Angle	2,35	30°	M 2	6	1,7	8,13
SIS-1104N	Straumann® Bone Level®	Ø 3,3	Torx	2,05	75°	M 1,6	7,85	1	
SIS-1114RC	Straumann® Bone Level®	Ø 3,3	Torx	2,05	75°	M 1,6	7,85	1,31	6,54
SIS-1114RC	Straumann® Bone Level®	Ø 4,1/Ø 4,8	Torx	2,05	75°	M 1,6	7,85	1,31	
SIS-2009	Straumann® Bone Level®	Ø 3,3/Ø 4,1/Ø 4,8	Smart Angle	2,3	75°	M 1,6	7,85	1	6,85
SIS-2009HG	Straumann® Bone Level®	Ø 3,3/Ø 4,1/Ø 4,8	Smart Angle	2,3	75°	M 1,6	12,5	5,65	
SIS-0624	Straumann® Tissue Level®	Ø 4,8/6,5	Torx	2,5	45°	M 2	4,45	0,95	3,5
SIS-0625	Straumann® Tissue Level®	Ø 4,8/6,5	Torx	2,6	75°	M 2	6,7	1	
SIS-2008	Straumann® Tissue Level®	Ø 4,8/6,5	Smart Angle	2,55	75°	M 2	6,7	1	5,7
SIS-2008HG	Straumann® Tissue Level®	Ø 4,8	Smart Angle	2,55	75°	M 2	10,6	4,9	
SIS-2010	Straumann® Tissue Level®	Ø 4,8	Smart Angle	2,5	45°	M 2	5,5	2	3,5
SIS-1405	Sweden & Martina Premium Kohno®	Ø 4,25	Hex. 1,27	2,5	30°	M 2	8,1	2	
SIS-1405N	Sweden & Martina Premium Kohno®	Ø 3,3 / Ø 3,8	Hex. 1,27	2,15	30°	M 1,8	7,45	2	5,45
SIS-2016	Sweden & Martina Premium Kohno®	Ø 4,25	Smart Angle	2,3	30°	M 2	6	1,5	
SIS-2021	Sweden & Martina Premium Kohno®	Ø 3,3 / Ø 3,8	Smart Angle	2,25	30°	M 1,8	7,1	1,45	5,65
SIS-2021HG	Sweden & Martina Premium Kohno®	Ø 3,8	Smart Angle	2,3	30°	M 1,8	9,6	3,95	
SIS-0351Z	Zimmer® Screw-Vent®	Ø 3,5/Ø 4,5/Ø 5,7	Hex. 1,27	1,95	20°	UNF 1/72	8,21	2,35	5,8
SIS-2007	Zimmer® Screw-Vent®	Ø 3,5/Ø 4,5/Ø 5,7	Smart Angle	2,3	20°	UNF 1/72	7,1	1,45	
SIS-2007HG	Zimmer® Screw-Vent®	Ø 3,5/Ø 4,5/Ø	Smart Angle	2,3	20°	UNF 1/72	10,2	4,55	5,65



www.sisaditamentos.com.mx



 **San Luis Potosí (Matriz)**
Artículo 123 #180 Int 201, Burócrata,
San Luis Potosí, S.L.P., México.
info@sisaditamentos.com.mx

 (444)-496-6776

 www.sisaditamentos.com.mx